

IDA

IDA MEMORANDUM REPORT M-317

File Copy

e

CRITICAL TECHNOLOGY ASSESSMENT IN ISRAEL AND NATO NATIONS

Edwin S. Townsley, IDA
Project Director

Clarence A. Robinson, LTI
Team Leader

April 1987

Prepared for
Office of the Under Secretary of Defense
(International Programs and Technology)



INSTITUTE FOR DEFENSE ANALYSES
1801 N. Beauregard Street, Alexandria, Virginia 22311

DEFINITIONS

IDA publishes the following documents to report the results of its work.

Reports

Reports are the most authoritative and most carefully considered products IDA publishes. They normally embody results of major projects which (a) have a direct bearing on decisions affecting major programs, or (b) address issues of significant concern to the Executive Branch, the Congress and/or the public, or (c) address issues that have significant economic implications. IDA Reports are reviewed by outside panels of experts to ensure their high quality and relevance to the problems studied, and they are released by the President of IDA.

Papers

Papers normally address relatively restricted technical or policy issues. They communicate the results of special analyses, interim reports or phases of a task, ad hoc or quick reaction work. Papers are reviewed to ensure that they meet standards similar to those expected of refereed papers in professional journals.

Memorandum Reports

IDA Memorandum Reports are used for the convenience of the sponsors or the analysts to record substantive work done in quick reaction studies and major interactive technical support activities; to make available preliminary and tentative results of analyses or of working group and panel activities; to forward information that is essentially unanalyzed and unevaluated; or to make a record of conferences, meetings, or briefings, or of data developed in the course of an investigation. Review of Memorandum Reports is suited to their content and intended use.

The results of IDA work are also conveyed by briefings and informal memoranda to sponsors and others designated by the sponsors, when appropriate.

The work reported in this document was conducted under contract MDA 903 84 C 0031 for the Department of Defense. The publication of this IDA Memorandum Report does not indicate endorsement by the Department of Defense, nor should the contents be construed as reflecting the official position of that agency.

This Memorandum Report is published in order to make available the material it contains for the use and convenience of interested parties. The material has not necessarily been completely evaluated and analyzed, nor subjected to IDA review.

Further dissemination only as directed by DUSDA/PA&T, The Pentagon, Washington, DC 20301-3070; 15 July 1987, or higher authority.

UNCLASSIFIED

SECURITY CLASSIFICATION OF THIS PAGE

REPORT DOCUMENTATION PAGE			
1a. REPORT SECURITY CLASSIFICATION UNCLASSIFIED		1b. RESTRICTIVE MARKINGS	
2a. SECURITY CLASSIFICATION AUTHORITY		3. DISTRIBUTION/AVAILABILITY OF REPORT Further dissemination only as directed by OUSDA/IP&T, The Pentagon, Washington, DC 20301-3070; 15 July 1987, or higher authority.	
2b. DECLASSIFICATION/DOWNGRADING SCHEDULE			
4. PERFORMING ORGANIZATION REPORT NUMBER(S) IDA Memorandum Report M-317		5. MONITORING ORGANIZATION REPORT NUMBER (S)	
6a. NAME OF PERFORMING ORGANIZATION Institute for Defense Analyses	6b. OFFICE SYMBOL (if applicable)	7a. NAME OF MONITORING ORGANIZATION DoD-IDA Management Office, OUSDRE	
6c. ADDRESS (City, State, and Zip Code) 1801 N. Beauregard Street Alexandria, VA 22311		7b. ADDRESS (CITY, STATE, AND ZIP CODE) 1801 N. Beauregard Street Alexandria, VA 22311	
8a. NAME OF FUNDING/SPONSORING ORGANIZATION OUSD/IP&T	8b. OFFICE SYMBOL (if applicable)	8. PROCUREMENT INSTRUMENT IDENTIFICATION NUMBER MDA 903 84 C 0031	
9c. ADDRESS (City, State, and Zip Code) Room 3E1082 The Pentagon Washington, DC 20301-3070		10. SOURCE OF FUNDING NUMBERS	
		PROGRAM ELEMENT	PROJECT NO.
			T-1-102
		TASK NO.	ACCESSION NO. WORK UNIT
11. TITLE (Include Security Classification) Critical Technology Assessment in Israel and NATO Nations			
12. PERSONAL AUTHOR(S) Edwin S. Townsley, Project Director			
13. TYPE OF REPORT Final	13b. TIME COVERED FROM 10/85 TO 5/86	14. DATE OF REPORT (Year, Month, Day) April 1987	15. PAGE COUNT 397
16. SUPPLEMENTARY NOTATION			
17. COSATI CODES			18. SUBJECT TERMS (Continue on reverse if necessary and identify by block number) Electronic surveillance, target acquisition, radar, electronic warfare, battle management, command, control and communications, Armor and anti-armor, Sensors, Optics, Tactical Munitions, Anti-theatre ballistic missiles, Directed Energy Weapons, Kinetic energy weapons, NATO conventional defense, Strategic Defense Initiative
FIELD	GROUP	SUB-GROUP	
19. ABSTRACT (Continue on reverse if necessary and identify by block number) <p>This report describes the technological details of basic research and development program thrusts in Israel, Italy, France, West Germany, and the United Kingdom with possible applications to U.S. Defense Department programs, both tactical and strategic. Technology assessments in this report are based on visits by a team of physicists and engineers to the research laboratories, production plants, and test facilities of 52 companies on a schedule of 28 days. The report provides a comprehensive critical assessment of technologies relevant to the new North Atlantic Treaty Organization (NATO) initiatives, Nunn Amendment programs and Strategic Defense Initiative (SDI) Organization programs. It covers technology facets of allied programs and seeks to provide a benchmark against similar kinds of technology already in development in U.S. industry and government laboratories. The team generally oriented its inquiries to the following areas of interest:</p> <ul style="list-style-type: none"> • Electronics, including surveillance, target acquisition, radar, electronic warfare, battle management, and command, control and communications. • Armor and anti-armor. • Sensors. • Optics. • Tactical Munitions. • Anti-theatre ballistic missiles. • Directed and Kinetic energy weapons technologies. <p>The report does not address policy issues or problems arising from technology transfer, security and SDI allied participation.</p>			
20. DISTRIBUTION/AVAILABILITY OF ABSTRACT <input type="checkbox"/> UNCLASSIFIED/UNLIMITED <input checked="" type="checkbox"/> SAME AS RPT. <input type="checkbox"/> DTIC USERS		21. ABSTRACT SECURITY CLASSIFICATION UNCLASSIFIED	
22a. NAME OF RESPONSIBLE INDIVIDUAL Edwin S. Townsley		22b. TELEPHONE (Include Area Code) (703) 578-2752	22c. OFFICE SYMBOL

DD FORM 1473, 84 MAR

83 APR edition may be used until exhausted. All other editions are obsolete

SECURITY CLASSIFICATION OF THIS PAGE

UNCLASSIFIED

IDA MEMORANDUM REPORT M-317

**CRITICAL TECHNOLOGY ASSESSMENT
IN ISRAEL AND NATO NATIONS**

Edwin S. Townsley, IDA
Project Director

Clarence A. Robinson, LTI
Team Leader

April 1987



INSTITUTE FOR DEFENSE ANALYSES

Contract MDA 903 84 C 0031
Task T-1-102

FOREWORD

IDA was asked by the sponsor to undertake the leadership for a task to assess in various countries the state of the technology base of potential use in military weapons systems. This report is submitted in fulfillment of that request.

The draft of this report was prepared for IDA by:

Leading Technologies Incorporated
1611 North Kent Street
Arlington, Virginia 22209

This report presents the findings of a team of experts assembled under the leadership of Clarence A. Robinson, Jr., President, LTI. They include:

Supriya Chakrabarti, Ph.D., Senior Fellow and Principal Investigator, Space Sciences
Laboratory, Berkeley

Wayne P. Gagner, President, S&W Associates

Kenneth Jordan, Ph.D., Vice President/Chief Scientist, SAIC

R. Norris Keeler, Ph.D., Consultant.

Based on the guidance of the sponsor, the team of experts visited, at times with IDA representation, selected companies and laboratories in Israel and Europe to evaluate their technology base. The United States Embassies in each country were notified by the Department of Defense of the visits and that the visits would be on an informal and unclassified basis. While the embassies were not asked to provide assistance, nonetheless they did provide assistance in varying degrees. Their assistance is appreciated.

At each company or laboratory, the team briefed the attendees on the purpose of the discussions and provided a nondisclosure agreement stating that the information received was for U.S. Government use only and would not be disclosed to U.S. industry or others. Therefore, to assist in the distribution of this report, the material has been screened by LTI to exclude company proprietary information. The excluded material is available to U.S. Government users through the sponsor.

The draft report was originally prepared as a briefing document and used in a series of briefings presented by the team to various offices and agencies of DoD. Subsequent to the submission of the briefing document to the sponsor, IDA and LTI revised the document to put it into the more conventional format herein.

CRITICAL TECHNOLOGY ASSESSMENT FOR ISRAEL AND NATO NATIONS

TABLE OF CONTENTS

SECTION I: Introduction

A.	Purpose of This Report	I-1
B.	Scope	I-1
C.	Charter and Objectives	I-7
D.	Technology Project Assessment Categories	I-7

SECTION II:

Science and Technology - The U.S. and Europe	II-1
--	------

SECTION III: Israel

A.	Overall Assessment	III-1
B.	Conventional Technology Assessment	III-1
C.	SDI-Related Technology	III-2
D.	SOREQ	III-4
E.	E1-Op	III-16
F.	Israeli Aircraft Industries	III-28
G.	ELTA	III-30
H.	Elisra	III-32
I.	Hebrew University of Jerusalem	III-34
J.	Rafael	III-38
K.	Elbit	III-46
L.	Israeli Military Industries	III-54
M.	Tadira	III-57

SECTION IV: Italy

A.	
B.	
C.	
D.	
E.	
F.	
G.	
H.	
I.	
J.	
K.	
L.	
M.	
N.	

SECTION V: France

- A.
- B.
- C.
- D.
- E.
- F.
- G.
- H.
- I.
- J.

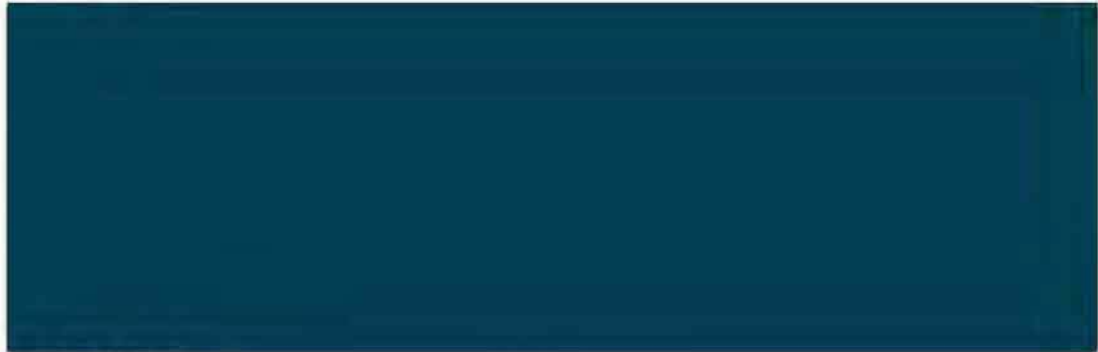

SECTION VI: West Germany

- A.
- B.
- C.
- D.
- E.
- F.
- G.
- H.
- I.
- J.
- K.
- L.



SECTION VII: Other NATO Countries

- A.
- B.
- C.



ATTACHMENTS:

- I. Introduction
- II. Lead Azide Laser - Negev
- III. Electro-Thermal Acceleration - SOREQ
- IV. HgZnTe IR Detectors - SOREQ
- V. E1-Op
 - A. Gelatin Holographic Optical Element
 - B. High Power Sealed CO₂ Laser
- VI. Wigglerless Kinetics - Hebrew University
- VII. Excimer Kinetics - Hebrew University, Racah Institute
- VIII. Plasma Detectors - Rafael
- IX. Software Logic - Rafael and Others
- X. Computer Vision - Elbit
- XI. Electronic Warfare
- XII. SIGINT - Octopus

- XIII. Tadiran
 - A. EW/DF and Emitter Location
 - B. C³I
 - C. EW, COMINT, COMJAM and ELINT

XIV. Lavi Electronics - Elta

XV. Airborne SIGINT

XVI.

XVII.

XVIII.

XIX.

XX.

XXI.

XXII.

XXIII.

XXIV.

XXV.

XXVI.

XXVIII.

XXIX.

XXX.

XXXI.

XXXII.

XXXIII.

XXXIV.

XXXV.

XXXVI.

XXXVII.

XXXVIII.

XXXIX.

XL.

XLI.



SECTION I

INTRODUCTION

A. PURPOSE OF THIS REPORT

This report describes in scientific terms the technological details of basic research and development program thrusts in Israel and selected European allied nations with possible applications to U.S. Department of Defense (DOD) programs, both tactical and strategic. The report is organized to provide a comprehensive critical assessment of technologies relevant to the new North Atlantic Treaty Organization (NATO) initiatives, Nunn Amendment programs and Strategic Defense Initiative (SDI) Organization (SDIO) programs.

The report avoids an analysis of policy issues and problems arising from technology transfer, security and SDI allied participation. It concentrates instead only on technology facets of allied programs and seeks to provide a benchmark against similar kinds of technology already in development in U.S. industry and government laboratories.

Technology assessments covered in this report are based on visits by a team of physicists and engineers to the research laboratories, production plants, and test facilities of 52 companies. The report encompasses data from technology assessments based on a schedule of 28 days available for the survey. This schedule was structured to provide a technological overview and to obtain data to enable identification of efforts that should be further investigated in detail for support by joint U.S.-Allied developmental programs.

This report highlights technologies that could materially aid the DOD in drawing together the alliance in joint programs to provide synergism from technologies on both sides of the Atlantic.

B. SCOPE

Assessment and analyses in the technology report are divided into the two tasks that are identified in the modified contract for this study. The first task calls for identification and assessments of those technologies in Israel that are relevant to the spectrum of SDIO programs, with possible spinoffs of those technologies for tactical developments.

A second task in the study is to assess and analyze the technological contributions that each of six nations--West Germany, France, The United Kingdom, Italy, The Netherlands and Denmark--could make in joint research and development programs in concert with NATO efforts. Visits to these latter two countries were not part of the study contract; however, several visits were made to investigate unique "targets of opportunity."

The team visits in each of the nations involved were structured to interface with engineers and scientists, not marketing or management personnel. Emphasis also was placed on visits to industry, with some laboratory exploration. Visits to national laboratories were generally as a result of personal contacts by team members with laboratory physicists. Such visits were usually scheduled after working hours and on weekends.

(See Attachment XL, European Laboratory Technology Assessment.)

Technology tends to be generic in nature with the application often across a broad spectrum of programs. In approaching the assessment, team members were instructed to orient visitors so as to obtain first-hand data from observing the technology and through visits to those directly involved in developmental effort. Each team member was instructed to avoid asking for SDIO-related technology data in the European nations, relying instead on possible

tactical programs, but keeping in mind SDIO spinoffs. The reverse was the case in Israel, where the team sought to avoid tactical programs, unless there were spinoffs that could be SDIO-related.

None of the nations visited is proficient in all of the technological areas investigated. But some nations have demonstrated capabilities in many areas of technology that team members found surprising in scope and depth. Even more surprising was the rapid rate at which technology is advancing among the allies, in some areas faster than progress in the U.S.

In assessing the allied technologies, the team generally oriented its inquiries along four areas of investigation:

- o Surveillance, radar, and command, control and communications
- o Armor/Anti-armor technology
- o Directed energy weapons
- o Sensor technology.

Developmental efforts were discovered in most of the nations that related directly to technologies, products, architectures, integration, operations and joint programs for theater ballistic and cruise missile defense, air defense programs and conventional defense initiatives.

Interaction between European nations and industry in development consortia was obvious throughout the assessment. In general, allies act together in developing military systems, both within Europe and in interfaces with Israel. Sharing the development funding load is a prerequisite in almost every major weapon system development, as is subsystem development where nations and companies excel in specific areas of technology.

The on-site assessment accomplished by the team members is contained in this report. It includes:

- o Surveillance, radar, and command, control and communications
 - Israel. There is a totally integrated effort in systems development throughout the nation. Electronic combat is an integrated system, not separated systems for the Army, Navy and Air Force. This includes from design phase electronic countermeasures, electronic intelligence (SIGINT/COMINT) and radar systems. Programs where important technology was identified include Elbit's programmable signal processing with VSLI as the basis for all development, and integration of surface acoustic wave devices with hybrid VSLI for signal processing at RF. Command, control and communications technologies are unique in Israel in terms of pace and integration of components into systems. The technology is in some instances more advanced than in the U.S. An example may be found in tactical spread spectrum systems that are not yet operational within our DOD but are already fielded in Israel. All levels of electronic warfare provide secure communications with developmental programs at companies such as Tadiran in HF, VHF, and UHF providing secure operations for all levels--ship, aircraft, tactical forces on the ground, and communications centers.

- Italy, 

[Redacted]

[Redacted]

France [Redacted]

[Redacted]

West Germany. [Redacted]

[Redacted]

[Redacted]

[REDACTED]

- **United Kingdom.** [REDACTED]

[REDACTED]

o **Armor/Anti-armor Technology**

- **Israel.** SOREQ is developing electron beam discharge plasmas to accelerate projectiles to hypervelocity using existing guns. This research should enable scaling to larger caliber projectiles at velocities of 2 km/sec., and is known as electro-thermal technology. Dr. Kaplan is conducting the research in this project. Rafael is developing and deploying reactive armor and pursuing more effective shaped charge designs to penetrate armor. There is close collaboration with MBB in West Germany, where tests have been conducted on captured Soviet-built armor. A sliding sabot armor penetrator also is being developed that increases operational effectiveness through very clever engineering.

Israel Military Industries is developing a ramjet propelled anti-tank missile, and is conducting research in several programs that could relate directly to SDIO kinetic kill vehicle weapons. Another concept in Israel is called Porcupine which disrupts penetrators and shaped charge implosion. Israel is the largest exporter of kinetic energy weapons in the Western world. Rafael also has developed a new self-forging tank penetrator.

- **Italy,** [REDACTED]

[REDACTED]

- **France.** [REDACTED]

[REDACTED]

- **West Germany.** [REDACTED]

[REDACTED]

[REDACTED]

[REDACTED]

[REDACTED]

o Directed Energy Weapons

- Israel's Negev Institute lead azide short wavelength lasers are being developed for space-based communications to submerged submarines for bellringer applications. The laser operates at 462 nanometers, and could be deployed to from an F-15 fighter similar to the U.S.A.F. anti-satellite miniature homing device.

Hebrew University has a concept and has conducted some studies on wigglerless FEL. Excimer laser research also is being carried out with a variety of applications including chemical kinetics in reactions in the excimer medium. El-Op is conducting research with high-powered carbon dioxide lasers that are sealed off, and developing laser radar tactical weapons with an increase in wallplug efficiency of a factor of two.

- **Italy.** [REDACTED]

[REDACTED]

- **West Germany.** [REDACTED]

[REDACTED]

o Mirrors. (See Attachment XLI, [REDACTED])

o Sensor technologies

- Israel. Work is in progress by Soreq with a new compound, MZT at 3-5 or 8-12 microns for increased reliability, sensitivity and shelf life. Another infrared technology development is Mercury Cadmium Telluride up to 10-in. diameter.

Plasma detector work is being done by Rafael to develop radiation hardened arrays against microwave radiation. El-Op is developing visual optics for night vision and unaided visual optics. Tadiran is working on an area of passive radar to detect and classify a single pulse signal.

- Italy. [REDACTED]

[REDACTED] to [REDACTED]

- France. [REDACTED]

- Germany. [REDACTED]

[REDACTED]

[REDACTED]

C. CHARTER AND OBJECTIVES

During the period that this work was in the planning stage, several changes were made in the scope of work and objectives to be met. Delays in carrying out the work were, for the most part, due to two reasons:

The original schedule would have required the fact finding trips to be done during the same time period as the Geneva Summit talks. There was some concern that the outcome of the summit might affect the scope of work, and that the presence of the team in Europe during the talks might be subject to misunderstanding and press exploitation. Therefore the trips to Europe and Israel were delayed several months.

The original scope included Japan. However, there were successive delays in scheduling a visit to Japan to the point that the requirement to include Japan was dropped.

As a result the final scope and objectives were slightly different for Israel and Europe. While in both cases, the team was to be alert to any militarily relevant technologies in which our allies exhibited strong capabilities, the emphasis in Israel was on theatre ballistic missile defense and by extension SDI, and the emphasis in Europe was on upgrading NATO conventional defense, NATO initiatives, and possible Nunn Amendment cooperative efforts.

The overall objectives were to identify potential areas of industrial collaboration and joint research and to assess the willingness to cooperate.

It should be noted that, with the team visiting 52 different organizations in five countries in one four-week period, the team was not able to go into full depth on all items. Therefore the recommendations are for further exploration of specific cooperative opportunities identified.

D. ASSESSMENT CATEGORIES APPLICABLE TO ALL TECHNOLOGIES ASSESSED:

CATEGORY I

- o Unique, innovative and different, technologically sound, something not being pursued elsewhere.

CATEGORY II

- o On a par with the state-of-the-art, good sound technology.

CATEGORY IIIA

- o Sound technology, but behind state-of-the-art.

CATEGORY IIIB

- o Interesting but insufficient information provided. Could be any of other categories.

The evaluation and assignment of technologies to an assessment category by the team was based entirely upon the information and data provided by the various companies. The team did not make an independent verification of the information received. Data cited and figures presented in the report are as given by the various companies. The attachments to the report are unedited versions of information the team collected. They have been selected

and are included as being representative of the data pertinent to those technologies assessed as Category I.

SECTION III

ISRAEL

A. OVERALL ASSESSMENT FOR ISRAEL

- o Military technology driven by Israel's peculiar threat and economic situation
 - Tactical orientation to most efforts with the possible exception of anti-tactical ballistic missiles requiring "strategic" approaches
 - Technology based on extrapolations of U.S. equipment and ideas
 - Rapid development and fielding of equipment
 - Developments oriented toward particular threats
 - Good research but laboratory capabilities weak (with a few exceptions) as well as weapons codes
- o As a result
 - Much Israeli fielded electronic warfare and communications equipment ahead of U.S. fielded equipment
 - Strategic Defense Initiative useful technology is a fallout from their tactical efforts
- o Israeli industry coordinated with the Ministry of Defense
 - Avoids duplication of efforts
 - Transfer of threat data and doctrine to all required companies
 - Extensive use of reserve military as design engineers and operational analysis

B. ISRAELI CONVENTIONAL TECHNOLOGY ASSESSMENT

1. *Armor/Anti-Armor Overview*
 - o First discovery of "active" armor (with MBB of Germany)
 - o Striking successes in protecting Israeli armored vehicles against shaped charges
 - o Practical orientation
 - o Oriented to present threat
 - o Quick to adapt concepts for practical use
 - o Excellent intelligence on future systems
 - o Continuous upgrading (in tests) of Israeli shaped charges

Israel has some capability in vulnerability and lethality studies. These are oriented to tactical rather than strategic systems. They work with MBB and other European defense contractors in their procurement of shaped charges, penetrators and active armor. The final designs of armor and munitions are highly sensitive, of course.

2. **Command, Control, Communications and Intelligence and Electronic Combat Overview.**
 - o A full spectrum of state-of-the-art communications equipment is available including digital, secure, frequency hopped, adaptive high frequency, and theater nodal networks with combined graphics or imagery, data, and voice
 - o Components and subsystems utilize high technology including
 - 2 u /12,000 gate very large integrated circuit
 - fast programmable signal processors
 - state-of-the-art surface acoustic wave devices used as filters, delay lines, and convolvers
 - o Airborne and surface systems provide accurate direction and identification within 1 degree direction of arrival (1.5 - 30 MHz HF band)
 - o Systems are pre-engineered for ECCM capability and are compatible with U.S. DOD airborne and ground standards (i.e. 1750A, 1553 DATA BUS)
 - o Some systems are form-fit improvements on U.S. equipment
 - o Excellent fundamental and applied software research
 - o Most capable, lowest cost infrared detectors
 - o Unique, standard architecture across Israeli industry of signal pre-processing at radio frequency using SAW devices

C. ISRAELI SDI-RELATED TECHNOLOGY

1. **Surveillance Acquisition Tracking and Kill Assessment Overview**
 - o Little or no overall systems capability but some innovative research on specific elements which could be significant
 - New, harder more reliable materials for infrared sensors
 - Hard microwave or millimeter wave imaging array using plasma detectors
 - Tunable lead salt lasers for heterodyne detection
 - o Some SDI applicable technology as fallout from tactical efforts
 - Adaptive, intelligent image processing techniques for target tracking and feature detection
 - Flexible, fast, programmable signal processor
2. **Battle Management/Command, Control and Communications**
 - o Research on rigorous software method

- State chart formalism for generation of specifications
- Correctness using formal methods of mathematical logic
- o Continual upgrade of systems to provide fast reaction indication and warning
 - Tri-modes of: threat indication, carrier weapon detection, and point defense
 - Extensive EW, and force multiplier capabilities in tactics and equipment

3. Directed Energy Weapons Overview

- o Excellent pulsed power, power conditioning effort
- o Innovative FEL effort
- o Calculations for nuclear pumped X-ray laser
 - Not as thorough as Lawrence Livermore National Laboratory
 - Lack of radiation-hydro capability and nuclear pumping limits project
- o Vulnerability, lethality capability
- o Detonation pumped laser (PbN3) calculations
- o Neutral; E-beam not pursued
- o Good analytic capability
- o Point defense - tactical applications

The Israeli pulsed power and power conditioning is limited in scope to laser, cyclotron masers, and relativistic electron beam applications. Although the current scope is narrow, the pulsed power work is first rate. Pulse power also constitutes a technology base for rail guns, charged or neutral particle beams should Israel choose to conduct work in these programs.

There are a number of interesting Free Electron Laser concepts being initiated in Israel. One of the more promising is the so-called "wigglerless" FEL, providing for a weight and cost reduction. This idea would eliminate a substantial metallic component of the FEL, providing for a weight and cost reduction. The unanswered question is whether the laser can scale to higher currents.

The Israeli AEC (Dimona/Beer Sheva) is actively pursuing a number of X-ray laser options. The nuclear pumped X-ray laser runs in parallel with radiation transport code development, but the USDOE X-ray laser program is more advanced. Several other promising ideas are also being pursued, including coherent radiation from channeled e-beams in crystals.

One of the more interesting laser projects is the proposal to build a chemical laser (in the visible) operating from detonation products. There are substantial difficulties with the practical realization of this idea, but if it could be done, both strategic and tactical implications would be enormous.

4. Kinetic Energy Weapons

- o Developed as fallout of anti-tank research efforts
- o Large foreign sales market

D. SOREQ

The SOREQ and the Dimona/Beer Sheva facilities are the equivalent of our Los Alamos, Lawrence Livermore and Oak Ridge National Laboratories. The SOREQ center runs the full nuclear gamut of activities from engineering, administration and non-destructive testing to electro-optics, pulsed power, process engineering and chemistry and nuclear research and safety. This is the technology base required for nuclear weapons design and fabrication. The facility operates an extensive contract research and development program, with contracts let to scientific services, prototype and small scale production.

SOREQ is following much of the technology which has been developed at Oak Ridge, Livermore, and Los Alamos. This also includes the use of lasers, pioneered in the U.S. to investigate the properties of radiative shock fronts, analogous to those which occur in nuclear explosive detonation. There is also extensive work being carried out in basic materials preparation; components and devices and pulsed power to e-beams and high energy lasers. Radiation technology involves use of flash X-ray radiography applied to destructive testing. This is required to diagnose the progress of the implosion of nuclear explosives. Also there is an effort in diagnosis of radiation effects on biological systems, including personnel, radiation safety and the application of tracers. Current density technologies are also exploited here, as is radiation chemistry which is concerned with the processing of various nuclear fuels.

The capability of SOREQ to support SDIO and nuclear technologies is almost an exact parallel of the capability currently existing at our National Laboratories. They are studying new optical radiation sensors, hardening of composite materials, and have proposed a number of X-ray laser schemes which can be either conventionally or nuclear pumped. They are studying damage mechanisms coupling spallation and fragmentation; and atmospheric detection and the effects of turbulence, radiation propagation through plasmas, ion sources and optics for directed energy weapons, and degradation of detector and electronic performance in the nuclear space environment. They use the same types of Lagrangian hydrodynamic codes using elastic-plastic deformation as are used by the Department of Defense and the Department of Energy. These, of course, find utility in studying the implosion of nuclear devices as well as studying spallation.

Their high explosive and laser workers have some interesting ideas in using detonation products as a source of excited species for lasing. One very attractive proposal is the use of lead azide to produce inversions in detonation produced lead atoms. This idea is a first of its kind and bears further investigation.

The use of the plasma and detonation codes to model the performance of hypervelocity guns is also a very fruitful idea. In addition to this work, they are also looking at some new semiconductor materials: a lead salt for a tunable diode laser, and mercury zinc telluride for IR detectors.

They are still hampered in being able to design and produce fusion weapons or other more complicated devices utilizing fusion and fission in the same configuration. As far as nuclear technology is concerned the Israelis are roughly where the U.S. as in the fission weapon field in about 1955 to 1960.

It should be noted that the Israelis are developing the kind of codes which will enable them to make hydrogen bombs. That is, codes which detail fission and fusion processes on a microscopic and macroscopic level. However, it is doubtful they have the codes to completely design such devices, as these involve more exotic radiation transport and are multidimensional. The Israelis do not yet have the capability to carry out these kinds of calculations.

SOREQ

- o Nuclear technology, weapons, nuclear power
 - Analogous to Livermore - LANL - Oak Ridge Laboratories
 - Weapons design extremely conservative
- o Plasma physics department
 - Developing the radiation transport codes-hydrogen bomb capability
 - X-ray laser studies
- o Solid state lasers - electro-optics
 - Solid state detectors
 - Vulnerability, lethality

CATEGORY I

- o Lead azide, short wavelength chemical laser - unique action from detonation products (NEGEV). Provides intense pulse of blue-green light at appropriate wavelengths to provide bellringer for deeply submerged strategic submarines.
(BM/C³, SDI) (See Attachment II.)
- o Electrothermal acceleration - simple retro of existing platforms to provide hypervelocity kinetic energy rounds.
(ATBM, ARMOR/ANTI-ARMOR, TACTICAL MUNITIONS, SDI) (See Attachment III.)
- o Mercury Zinc Telluride detector work - provides long shelf life to IR detector capability (by a factor of 5)
(OPTICS, SATKA, BM/C³, SDI) (See Attachment IV.)

CATEGORY II

- o HgCdTe Large diameter detectors (10")
- o Lead salt tunable diode laser

CATEGORY IIIA

- o Nuclear explosive support work

SOREQ HgZnTe IR DETECTOR

SOREQ Nuclear Research Center is conducting research and development with the application of Mercury Zinc Telluride to infrared detectors. The variation of lattice constant is depicted in the composition as amounts of Mercury and Zinc are varied in the alloy. This lattice parameter determines sensitivity as a given wavelength.

SOREQ

HgZnTe IR DETECTOR

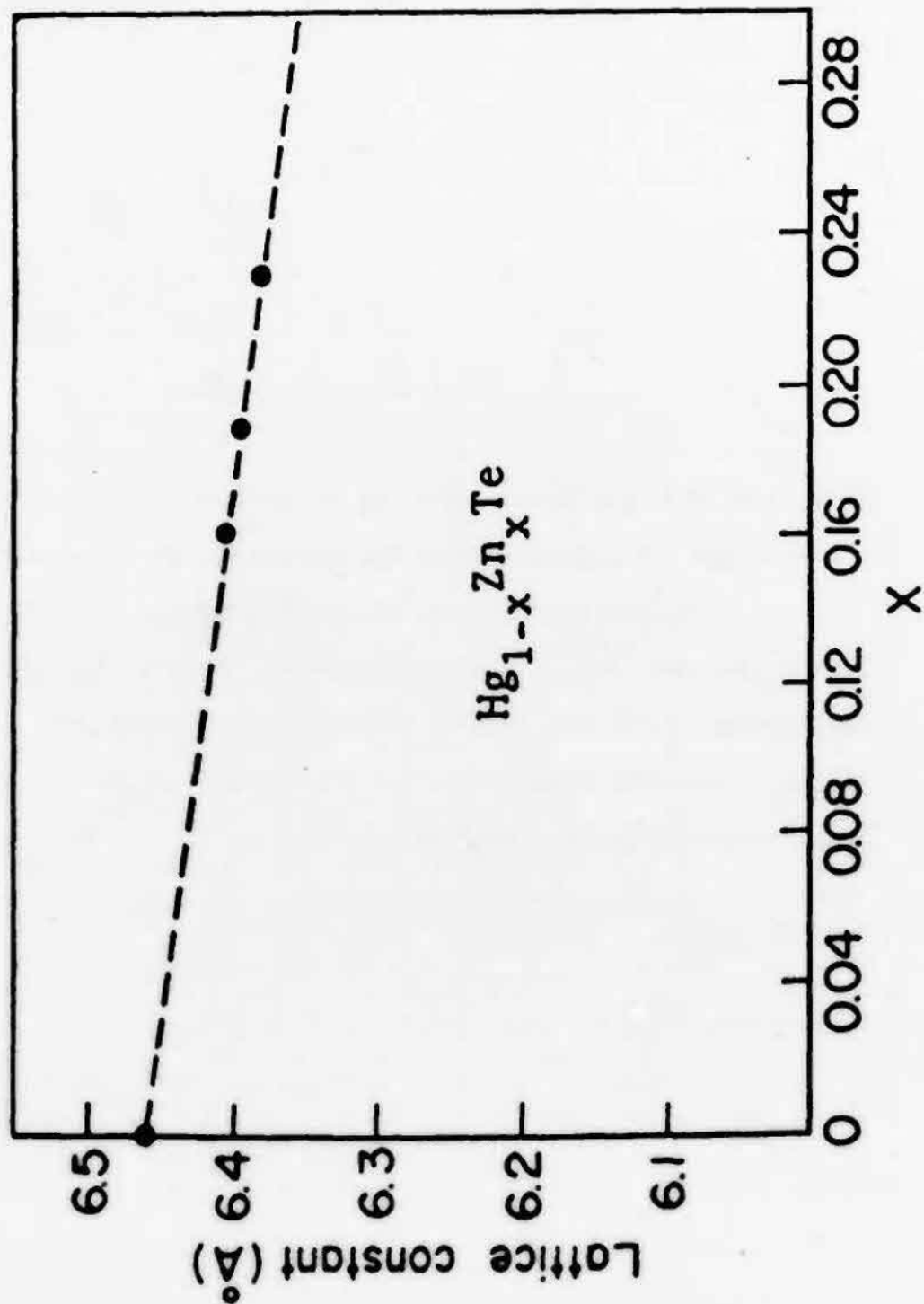

SOREQ HgZnTe IR DETECTOR

Israel's SOREQ nuclear facility is developing IR detector materials with increased sensitivity and longer shelf life using Mercury Zinc Telluride, HgZnTe. Note that the band gap changes strikingly as a function of composition. Overlap is observed at lower Zinc concentrations, evidence that the transition is made from semiconductor to metal. Varying the energy gap at given temperatures increases detector sensitivity. Note small graphs at right, illustrating intensity as a function of angle. The peak is caused by X-ray diffraction from the surface. This is associated with the lattice parameter.

SOREQ

HgZnTe IR DETECTOR

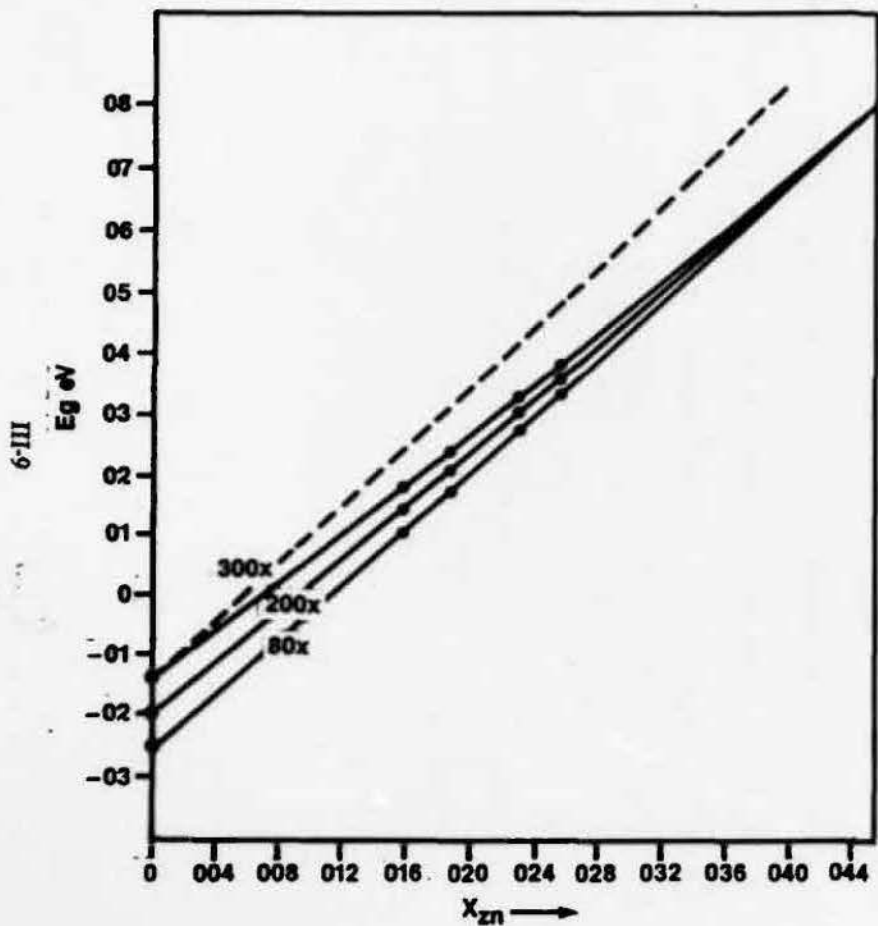

— ENERGY GAP OF $Hg_{1-x}Zn_xTe$
 - - - LINEAR INTERPOLATION BETWEEN HgTe AND ZnTe AT 300 K

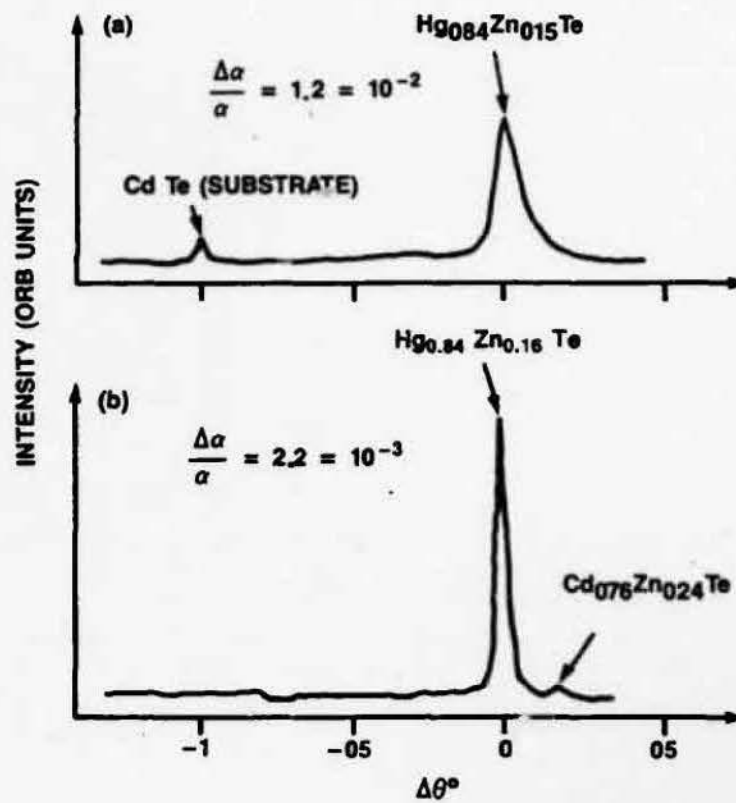

DOUBLE CRYSTAL X-RAY ROCKING CURVE

SOREQ ELECTROTHERMAL GUN

Electrothermal Gun Schematic diagram depicts the SOREQ electro-thermal gun used in laboratory experiments. The gun uses electrical energy to vaporize an ablating material, Teflon, converting it into a plasma jet to propel projectiles at hypervelocities. Hydrogen from either water or paraffin at the projectile base is used to propel the round seated by the plasma jet. It is believed possible to scale this technology concept from the present .50 caliber gun to 105 mm application to exploit railgun performance parameters with standard artillery. Velocities up to 4 km/sec are considered feasible.

SOREQ

ELECTROTHERMAL GUN

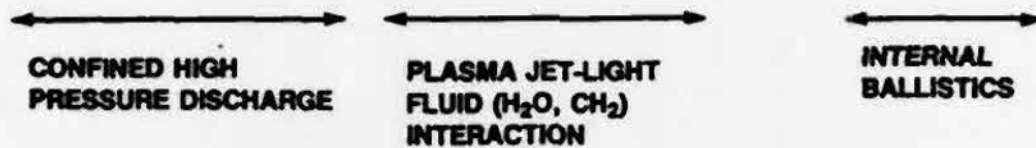
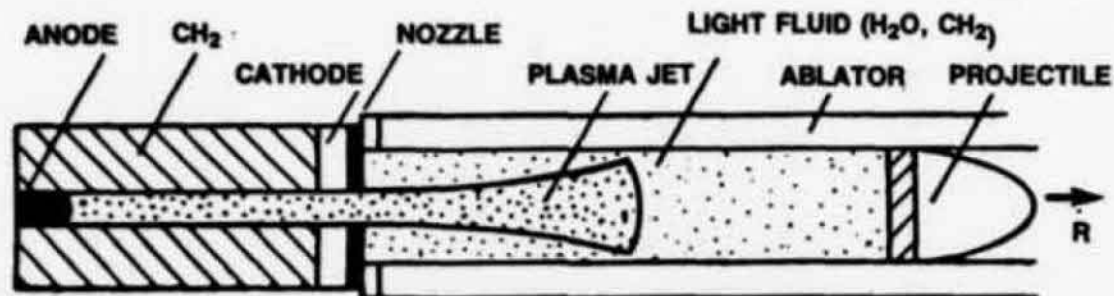

THERMAL PRESSURE GUN

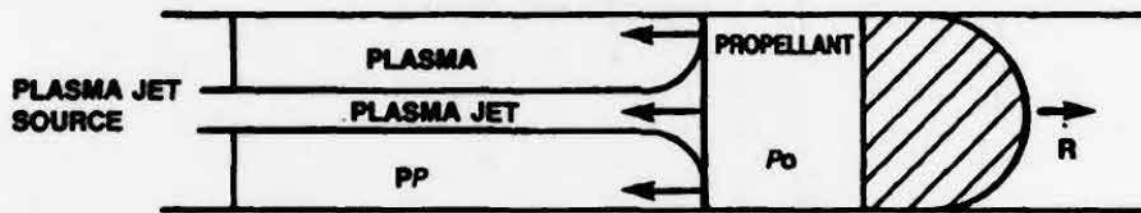

TRAVELING CHARGE GUN

III-11

NEGEV LEAD AZIDE SHORT WAVELENGTH CHEMICAL LASER

Israel is developing a laser pumped by the detonation product lead azide. The energy level of the laser is formed by the detonation depicted in the graph. The activated lead atom is the product of the detonation and corresponds to laser radiation at a wavelength of 462 nanometers, close to the most effective wavelength to penetrate the ocean to significant depths. The technology is planned for laser communications as a compact, inexpensive device to use as a bellringer system for submarines. It also could be used for countermeasures against IR sensors on the tactical battlefield and in space.

NEGEV

LEAD AZIDE, SHORT WAVELENGTH CHEMICAL LASER

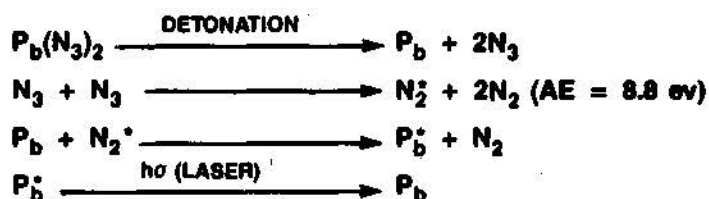
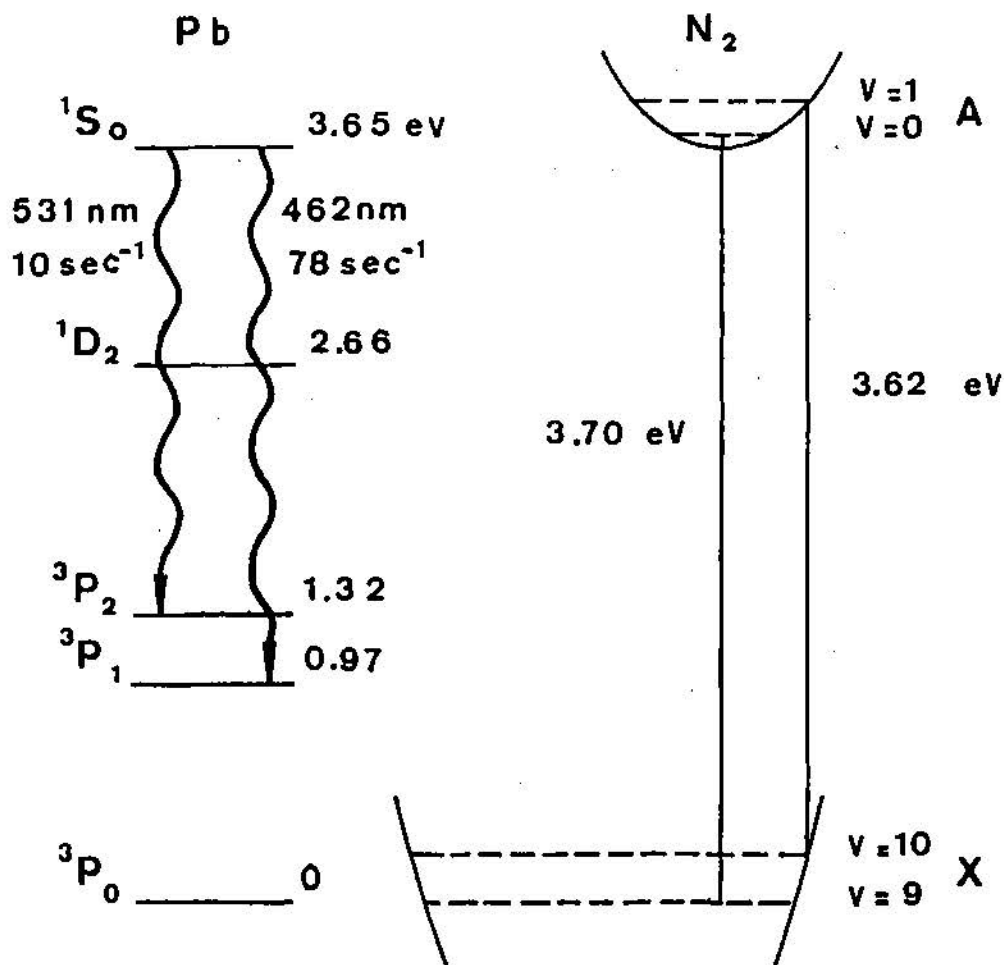

SOREQ LEAD SALT TUNABLE DIODE LASERS

The configuration of SOREQ's laser is depicted for heterodyne detection of infrared energy from a remote source. This tunable device technology could provide shot noise limited, frequency stable, single mode lasing features. Graph at right depicts the increase efficiencies from heterodyne detection as opposed to direct detection.

LEAD SALT TUNABLE DIODE LASERS - SOREQ

INFRARED HETERODYNE DETECTION

- Principles -

In heterodyne detection, infrared radiation from a remote source is mixed with the output of a coherent local oscillator.

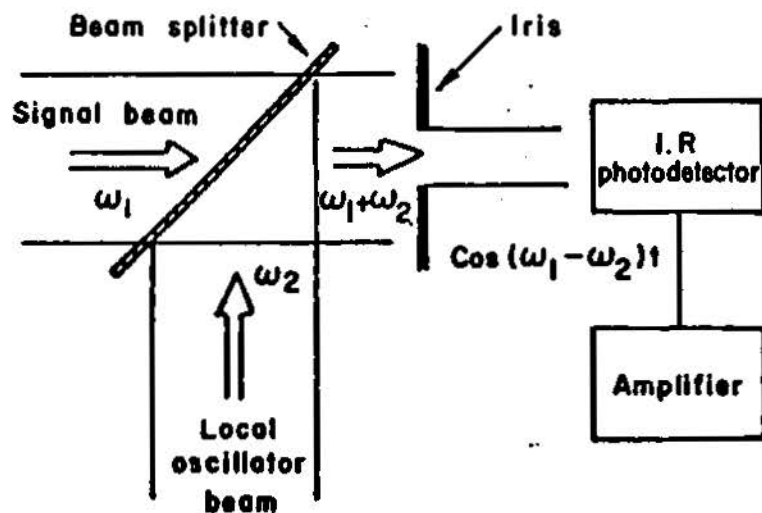

III-15

INFRARED HETERODYNE DETECTION

- comparison of the efficiency of heterodyne vs direct detection.

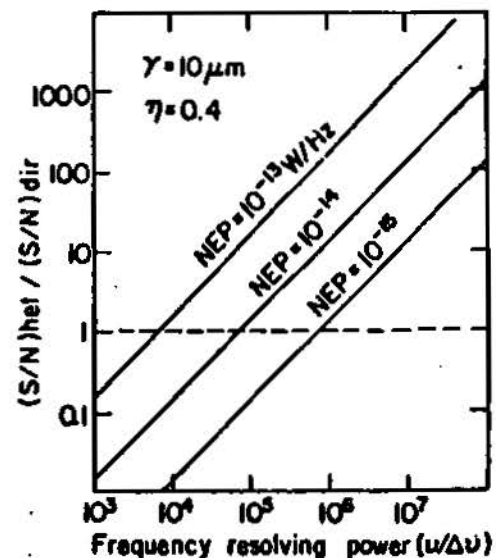

Thus, for Doppler limited molecular emission ($\nu/\Delta\nu \sim 10^6$) and $NEP=10^{-13}$ W/Hz, a 100-fold improvement is obtained.

THESE TDL'S HOLD PROMISE OF

- LASING IN SINGLE MODE
- SHOT NOISE LIMITED
- FREQUENCY STABILITY
- SUFFICIENT POWER (1 MW)

COMMERCIALY AVAILABLE TDL'S ARE NOT GOOD ENOUGH

E. EL-OP

El-Op has a long history of operations dating from 1937 with partial Israeli state ownership from 1962. The company employs 1200 personnel for research and production of optical systems for tank fire control, lasers, thermal imagers, night vision, avionics and opto-mechanical products.

Tank fire control systems include product improvement systems for older systems, total replacements, and state-of-the-art integration for new tanks.

Laser systems include rangefinders and designators for ships, helicopters, aircraft, and anti-aircraft and anti-tank systems.

Thermal imaging products are produced for passive detection, surveillance, and weapon aiming systems.

Image intensification products include the full spectrum of devices from goggles to tank driving systems.

El-Op provides heads up displays (HUD) for all Kfir and Skyhawk aircraft. New generations of heads up displays are being developed using holography for next generation aircraft.

The opto-mechanical devices produced by El-Op include boresight, test, observation, and compass equipment to support weapon systems.

El-Op produces a variety of systems that respond to military needs for optics and electro-optics at all levels of tactical equipment.

GENERAL

- o El-Op is about a \$900 million-a-year company of 1200 personnel specializing in R&D and production of electro-optical devices. It is jointly owned by Tadiran and the Feuermann group.
- o Systems and research includes support for areas of avionics, night vision, thermal imaging, tank fire control, optical/mechanical devices.

CATEGORY I

- o Helmut HUD utilizing thin gelatin holographic element for total flight data presentation and enabling pilots to be protected from optical jamming regardless of his head position. Other applications are IFF and stealth.

(OPTICS) (See Attachment V.A.)

- o High power sealed off CO₂ laser. Can be used to blind sensors. Easy to maintain.

(ELECTRONIC COMBAT, DEW, SDI) (See Attachment V.B.)

CATEGORY II

- o **Thermal imaging devices (LIROD)**
- o **High repetition laser rangefinder (HRLR)**
- o **Stabilized fire control system (FSC)**
- o **Muzzle reference sensor (MRS)**
- o **Wild field of view HUD for Lavi, multicolor symbology display**
- o **Development of IR sensor for discriminating against pen aids**

CATEGORY IIIA

- o **Computer controlled optical surfacing machine**
- o **Development of wavelength dependent choppers**
- o **Optical coatings for high energy lasers**

CATEGORY IIIB

- o **Stabilized heterodyne systems**

EL-OP HIGH POWER, SEALED OFF CARBON DIOXIDE LASER

A 10-Kilowatt, 10% efficient carbon dioxide laser is being developed by El-Op in Israel. The device is completely enclosed, and is made possible by very efficient heat transfer. The maximum amount of surface in this design is exposed to the heat exchange medium. The laser path is lengthened to accommodate surface cooling. The performance is the best for a known enclosed-cycle laser in the West. The laser could be used on spacecraft, or in a variety of other applications, such as sensor countermeasures.

EL-OP

HIGH POWER, SEALED OFF CO₂ LASER

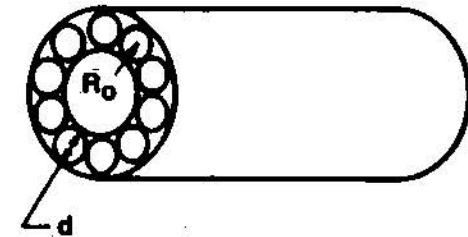
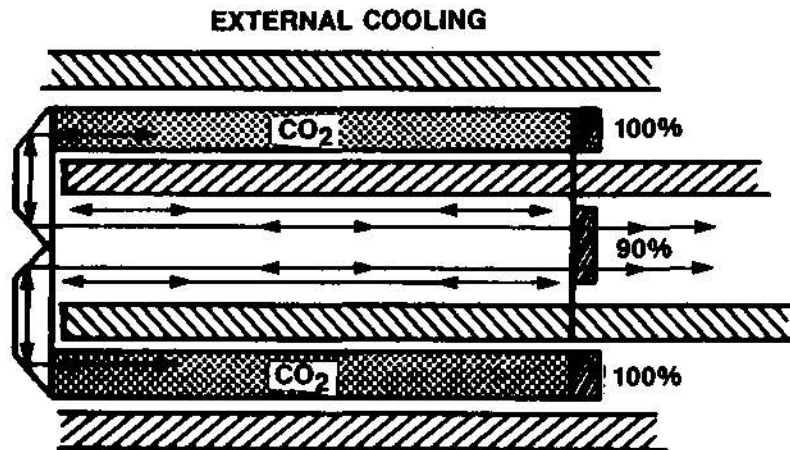

IMPROVING THE HEAT REMOVING
BY DESIGNING THE LASER IN
COAXIAL CONFIGURATION

AS CAN BE SEEN WE EFFECTIVELY
HAVE $2\pi R_0/D$ "SMALL LASERS"
CALCULATION SHOWS:

$$P_c/P_t = 6.4 R_0/D$$

III-19

EL-OP - MULTIFUNCTIONAL COMPONENTS

Holographic Optical Elements (HOE) developed by El-Op are based on the properties of gelatin. The HOE is lightweight and inexpensive as replacements for lenses, prisms, and filters. The technology is used with computer generated holographs. It also has infrared low observable applications for aircraft and missiles.

EL-OP

* MULTIFUNCTION COMPONENTS

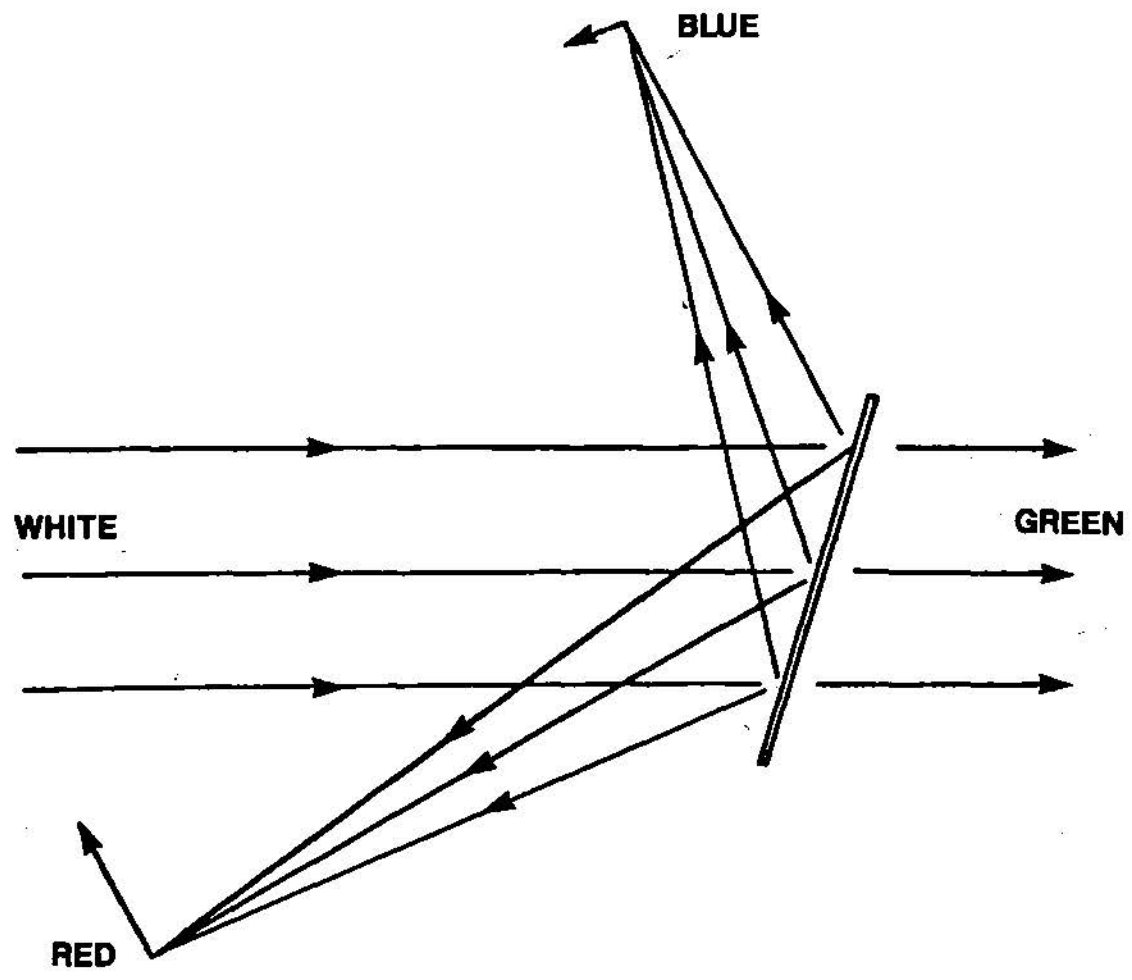

III-21

A SINGLE HOE CAN BE USED TO REPLACE LENSES, PRISMS AND SPECTRAL FILTERS

EL-OP HOLOGRAPHIC OPTICAL ELEMENTS

There are numerous applications for HOE technology. El-Op has specifically applied this technology to a Helmet Display System (HDS) to increase a combat pilot's first-shoot time with complete freedom of head movement. The HDS measures line of sight, range to target, ballistics, wind data, etc. The collimated image is transferred through fiberoptics from a high brightness CRT. The image is projected and seen by the pilot properly oriented regardless of head position, enabling freedom to monitor cockpit displays as well as outside scenarios.

EL-OP HOLOGRAPHIC OPTICAL ELEMENT

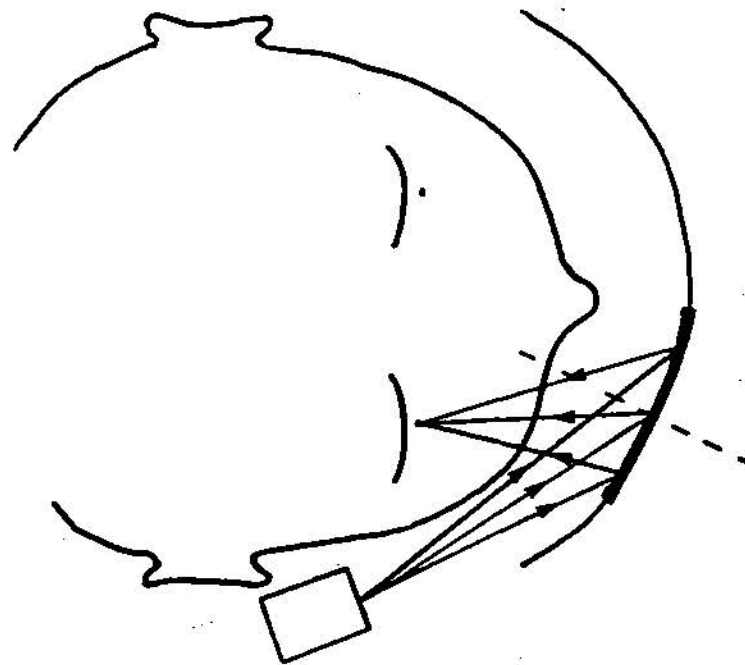
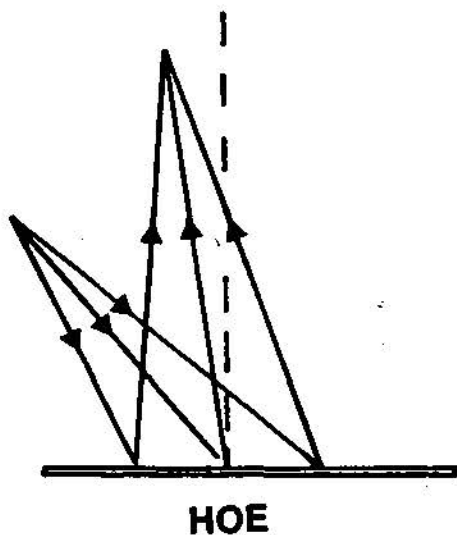
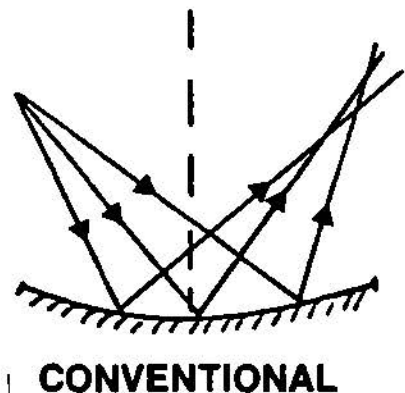

TO FIRST ORDER, A HOE IS NOT AFFECTED BY THE SHAPE OF THE SUBSTRATE

III-23

EL-OP SPECTRAL AND ANGULAR SELECTIVITY

The thin film holographic optical element is highly selective in wavelength, avoiding the three apex lines with high accuracy of the deflection angle. One application is for Identification Friend or Foe (IFF), or for stealth applications in the visible or IR regions. As depicted, the bandwidth is extremely narrow in the vicinity of 25 nanometers over a variation angle incidence of 10 degrees in spectral response. The see-through response is also depicted between 400 and 700 nm.

EL-OP SPECTRAL & ANGULAR SELECTIVITY

"SEE-THROUGH" RESPONSE

SPECTRAL RESPONSE OF A HOE

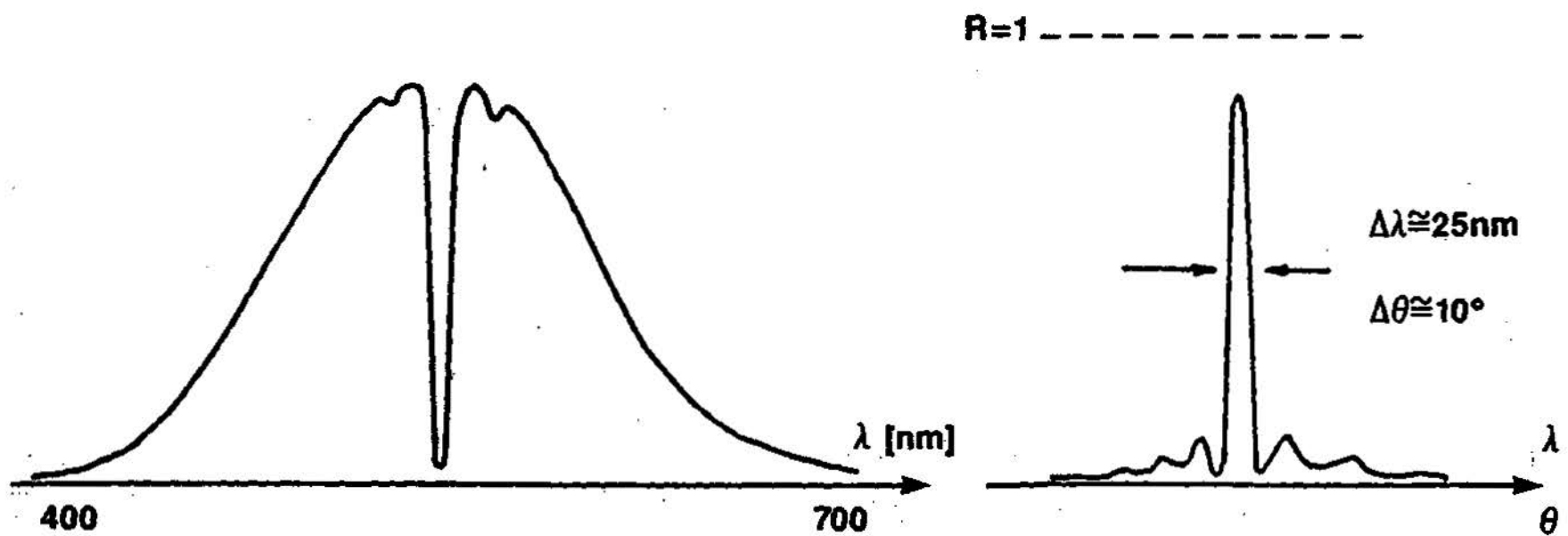

III-25

EL-OP ZIGZAG SLAB LASER

Israel's El-Op has developed a zigzag slab laser designed with an unstable resonator. The advantage of this design, depicted in the schematic diagram, is that it employs very thin slabs. This presents the same amount of lasing material as in larger, heavier devices to the light beam as it passes through the cavity. The concept is similar to one conceived by Ray Kidder at the Lawrence Livermore Laboratory. It has optimal pumping and heat transfer characteristics. The design provides ease in pumping the slabs since there are no large inhomogeneous areas that are not used in the process.

EL-OP

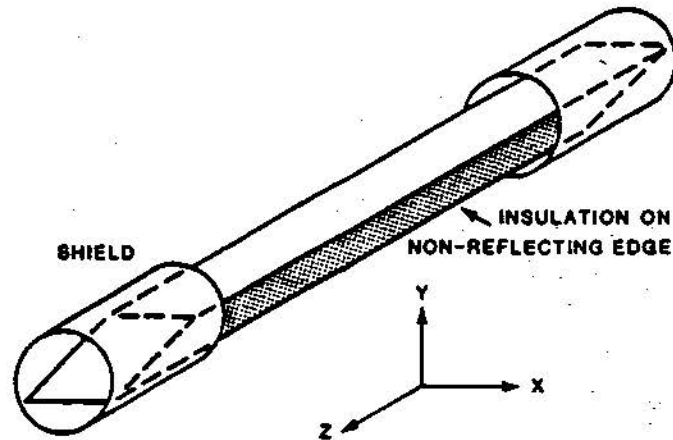

**THE ZIG-ZAG SLAB LASER GEOMETRY,
WITH SHIELDS AND INSULATION**

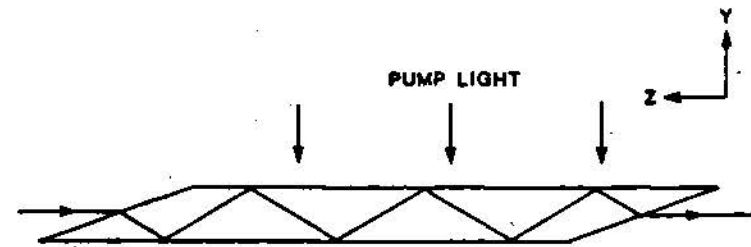

RAY PATH THROUGH THE ZIG-ZAG SLAB

III-27

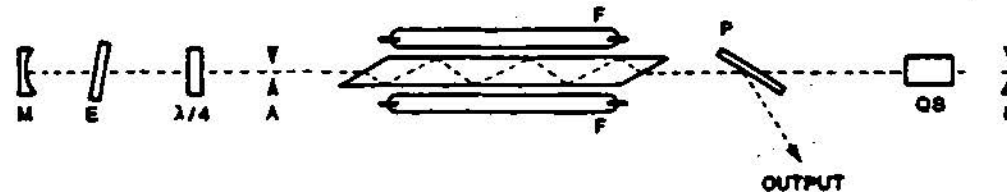

F — FLASHLAMP, M — 100% REFLECTING CONCAVE MIRROR,
 E — ETALON, P — POLARIZER, A — LIMITING APERTURE,
 QS — LITHIUM-NIOBATE Q-SWITCH, $\lambda/4$ — QUARTER-WAVE PLATE

ZIG-ZAG SLAB LASER WITH UNSTABLE RESONATOR

F. ISRAELI AIRCRAFT INDUSTRIES (IAI)

Israeli Aircraft Industries Ltd., is Israel's largest company with annual sales of \$900 million and 20,000 employees. Total research and development activities are 41% of the total output, with most of the funding from the government. IAI funded R&D is approximately 6% annually. Export sales are approximately \$450 million annually. Major business areas are design, development, test and certification of military and commercial aircraft, advanced aerospace and weapons systems, electronic and avionics systems. More than 30 types of aircraft have been built by IAI along with the 30 types of engines and 10,000 components. Annual capacity in these areas is 350 aircraft and 750 engines.

General research and development programs include air defense suppression, air defense and attack aircraft, missiles and guided armaments. Specific areas of R&D emphasis are:

- (1) Elta Electronics Company, a unit of the Electronics Division, with activity in precision guided munition control, secured communications, airborne radars with programmable signal processors and look-down capability backed up with a distributed computer network. Surface radars are being developed to detect sea-skimming missiles at 20 km, and tactical surface to surface system with a 120 km. range.
- (2) Tactical and strategic intelligence systems integrated into command control and communications systems.
- (3) Point defense weapon systems for strategic defense of high-priority targets.
- (4) Communications that include secured data, digital format and wide band via satellite and fiberoptics.
- (5) Communications intelligence with high sensitivity, fast scanning and broadband receivers.
- (6) Jammers for application against tactical and space-based communications systems.
- (7) Radar technology development in synthetic aperture and inverse synthetic aperture radar, radar image processing, solid state space qualified transmitters and receivers, RF tubes in X/K_u-K_a bands, large non-rigid antenna arrays that are lightweight, space-based radar signal processors that are programmable for onboard real-time processing of raw data, and bi-static cooperative and non-cooperative space-based radars.
- (8) Active electronic countermeasures, self-defense of aircraft and weapons systems against radar-guided threats.
- (9) Design and development of high reliability hybrid circuits and very large scale integrated circuits.

GENERAL

- o IAI is a major aerospace company producing state-of-the-art fighter aircraft such as the Lavi and Kfir, commercial aircraft, missiles and RPV's and electronics and avionics systems.
- o Major areas of business are airframe design and manufacture, development and production of weapons systems, and electronic and avionic systems such as radars,

communications, electronic warfare, signal intelligence, and command, control and communications systems.

- o General research activity is in areas of space related technologies such as embedded computer systems, flight and space structures, radar technologies, communications systems, computer technologies, signal processing and microelectronics technologies. Specific research and development program include:
 - Look-down/shoot-down radar for the Lavi fighter and an electronic warfare suite for the aircraft.
 - Radar mounted on vehicles to detect hovering helicopters now being tested and evaluated by the USMC with possible Lear-Siegler Production.
 - Tactical air defense radar that is rugged and uncomplicated. It operates at L-band and is solid state.
 - Long-range ground surveillance radar that can detect forces and mobile targets at ranges in excess of 100 km, operating with high resolution above X-band.
 - Image processing, artificial intelligence that is knowledge based/pattern recognition. Development of software for relative digital automatic pilot and control systems.

CATEGORY I

- o Two-layered anti-tactical ballistic missile defense system using remotely piloted vehicles and drones. Orbiting attack drones, very small size, made from low radar cross section materials, and equipped with warheads and terminal sensors such as infrared would be used against boosters in the boost phase. A second high-altitude layer would attack re-entry vehicles after launch from an RPV platform using infrared, ultraviolet or RF seekers. Dual-mode sensors are being developed that could be used on the drones.

(SDIO, ATBM)

- o Systems architecture for regional ballistic missiles defenses that could apply to SDIO, or for ATBM use. This is based on signal processing command, control, and communications systems with hardware in the loop with the capability for inputs from NATO allies in a layered terminal defense approach. This effort could be in cooperation with the MOD.

(BM/C³, ELECTRONIC COMBAT)

G. ELTA

ELTA Electronics Industries employs 2200 people with over 1200 scientists, engineers, programmers and high level technicians. The company produces \$140 million in products.

ELTA manufactures the following:

- o Radars - airborne, shipborne, and ground-based.
- o Electronic warfare - airborne, shipborne and ground-based.
- o SIGINT - EIINT and COMINT systems.
- o Communication - systems and equipment.
- o Computerized Systems - military types.
- o Automatic Test Systems - for military and industrial applications.
- o Signal processing.
- o National Defense - air defense C & C systems.
- o Technologies - microelectronics, transformers, filters, etc.

The great majority of the equipment and systems produced by ELTA are original developments. ELTA has an in-depth capability for turnkey delivery definition phases, site surveys, development of hardware selection and evaluation of subcontractors, production, software preparation, installation, commissioning, training and maintenance. ELTA is the avionics manufacturer for the Lavi aircraft and will provide EW, radar, and communication systems.

GENERAL

- o ELTA is a subsidiary of IAI (Israel Aircraft Industries).
- o Their products consist of: electronic warfare, SIGINT, communications, radars, computers, signal processing, C³I, and microelectronics equipment.

CATEGORY I

- o Programmable signal processor with modular parallel processing that is capable of network (Octopus) or stand-alone operating with math calculations of 90-540 NS and FFT (Butterfly).

(SDIO, ELECTRONIC COMBAT) (See Attachment XII.)
- o Conformal array technology for Lavi aircraft. SAR/ISAR capability for air and ground application.

(SDIO, ELECTRONIC COMBAT) (See Attachment XIV.)
- o Radar signal processing capability (EL/SP 890L) SAW integrated 12k gate 2 micron VLSI Circuit with parallel processing, 1.6 bit floating + fixed, and 2.5 GHz processing, signal compressing software for image processing (reconnaissance) and AI Function.

(SDIO, ELECTRONIC COMBAT) (See Attachment XV.)

CATEGORY II

- o **EC-135 (707) airborne system with parallel processing (Butterfly), HF/UHF, radar D.F., single pulse I.D., miniature amplifiers for monopulse down converting, frequency agile emitters, and phase locked loop synthesizers.**

H. ELISRA

Elisra Electronic Systems, Ltd., is primarily engaged in the development and manufacture of electronic warfare systems, equipment and components. Since its founding in 1966 (as A.E.L. Israel Ltd.), Elisra has been a major supplier to all branches of the Israel Defense Forces, as well as to customers world-wide.

Company sales reached \$70 million in 1985. About 45% of total sales are exports to other governments and armed forces. Elisra employs over 1400 people, of whom 200 are engineers and 500 are technicians. The company's premises, with 2800 square meters of floor space, and located in Bene Beraq, a suburb of Tel Aviv.

In the electronic warfare domain, Elisra is involved in the design and manufacture of:

Airborne EW systems for first line aircraft and helicopters
Naval EW suites (ESM/ECM) for all types of combat ships

These computerized power management systems include chaff dispensers and high-power jammers.

ELINT/COMINT equipment and systems, widely used for tactical and strategic intelligence for naval, ground, and airborne applications.

Communication equipment and systems, manufactured for HF to the microwave frequencies, utilizing Elisra's own high-power, broad-band, solid state amplifiers.

The company provides turnkey EW projects, starting from analysis of operational requirements through design, development and manufacture. The projects are accompanied by complete integrated logistic support packages that include training, documentation, software and spares.

GENERAL

- o Elisra is a company of 1485 personnel with annual sales of \$70 million. (AEL owns 60% of company stock)
- o The company is heavily involved in electronic warfare systems and radio frequency and microwave components.
- o Electronic warfare efforts include high frequency/microwave, ELINT/COMINT, for air and naval systems.
- o Components include: radio frequency amplifiers, solid state switches, filters and couplers, and wide range of power and frequency control devices.

CATEGORY I

- o Operational laser warning receiver with L.O.B. less than one degree. (MIL-E-5400) Ada processors with matching library and .1 micro second accuracy. Warns when being painted by laser.

(OPTICS, SATKA)

CATEGORY II

- o **RWR equipment similar to ALR 46,74/09 (Reprogrammable by tape upgrade and compatible with U.S. standards). Airborne ELINT systems with 4 antennae quadrants (model CR2800) providing 360 degrees coverage, 5 degrees AOA, and fingerprint capability MIL standard 1750 A computer.**
- o **CWDF for 6.5 - 18 GHz with a weight of 3 kg. (MIL-E-5400)**
- o **Naval ESM (radar DF) 2-18 GHz; DF one degree -X/k_u bands (3 degrees S&C bands), monopulse switching mode, in a density of 500 KPPS.**
- o **Ground ELINT 0.5 - 40 GHz, 100 KHz accuracy and resolution, DF .1 - 1 degree, PRI accuracy 100 NS per pulse train.**
- o **Ultra compact CO₂ laser, 200-1000 watts, industrial applications.**

I. HEBREW UNIVERSITY OF JERUSALEM

The following relates to work at the Hebrew University of Jerusalem, in particular the Racah Institute for Physics at the Center for Plasma Physics. Guillo Racah was a famous Italian Jewish physicist who emigrated to Israel and taught at the Hebrew University. His major contributions were in nuclear and high energy physics. His son teaches at the University of Illinois (Chicago) (he is head of the department there). The Institute for Physics was established in his name at the Hebrew University.

One of its most prominent activities is the Center for Plasma Physics. Much of the free electron laser work, which has been discussed elsewhere in this report, is going on at the Center for Plasma Physics in collaboration with investigators at the Office on Naval Research, at Yale University. The analytical potential and expertise in this field of plasmas, which is important to the operation of a free electron laser, exists at the Hebrew University. Therefore, as discussed in a subsequent document, it is recommended that the analysis and theory be done at Hebrew University with computer simulations done in the US, perhaps at the Naval Research Laboratory at Yale University, with the experimental parts of the program divided between Israel and the U.S.

Another exceptionally interesting project is the proposal to do excimer laser kinetics by Rokni and others. It is necessary to gain a better understanding on how excimer can be made more efficient.

Of course, Hebrew University also is the center for computer software research involving potential SDI projects and these are discussed also elsewhere in this report.

HEBREW UNIVERSITY OF JERUSALEM

- o **Racah Institute of Physics (Guillo Racah)**
 - Close collaboration with Rafael, SOREQ, U.S.
 - Development of wigglerless FEL
 - Collaboration with Yale University faculty
 - Excimer laser studies
 - Kinetics and energy distribution measurements on excimer lasers

CATEGORY I

- o **Wigglerless free electron laser - elimination of a massive component used to stimulate optical emission. Tremendous saving in weight and reduction of space.**
(OPTICS, SATKA, DEW) (See Attachment VI.)
- o **Excimer laser kinetics studies which greatly increases effectiveness of excimer laser.**
(OPTICS, SATKA) (See Attachment VII.)

(This page left blank intentionally.)

HEBREW UNIVERSITY WIGGLERLESS FREE ELECTRON LASER

Racah Institute of Hebrew University has developed a concept for a lightweight, less costly free electron laser that employs microwaves instead of wiggler magnets in the lasing process. The technology is based on the use of a two-beam accelerator using magnetic fields. Electrons from the accelerator are introduced at 3 MeV with a 3-kiloamp current at an angle to the magnets to produce a spatially coherent helical orbit that is produced for the electrons. Radiation from stage one is coupled with radiation from stage two as the driver for antiresonant acceleration in the second stage. A tapered light pipe is used to focus radiation for acceleration and focusing efficiency. This concept can produce 10 MeV electron beams. An intense electromagnetic wave is generated with circular polarization through the use of the magnetic field in the first stage. The transverse electromagnetic wave accelerates charged particles in the second stage that move in resonance with the wave--the gyro-resonance accelerator. MIT also is developing similar wigglerless FEL technology. The compact nature of the second stage makes this concept attractive.

HEBREW UNIVERSITY

WIGGLER LESS FREE ELECTRON LASER

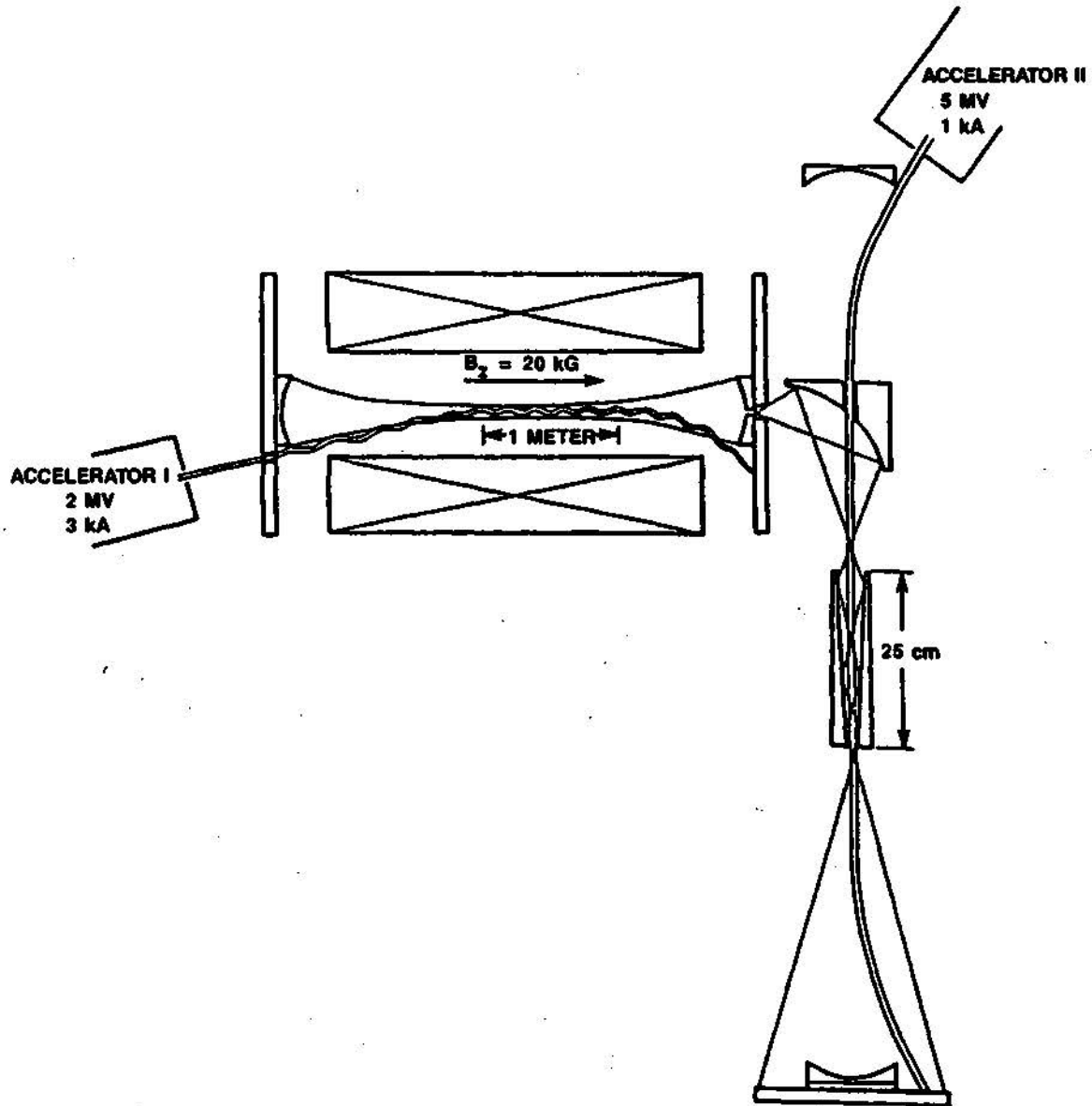

J. RAFAEL

Rafael is a key research and development laboratory in Israel, performing in a variety of technological areas. Major areas of development include missile systems design and development, image processing, and ballistic systems such as warheads and terminal devices, ceramic and composite materials applied to space reactive armor. Research and development programs are keyed to short-term responses to fulfill immediate needs of Israel in responding to threats along its borders, usually Soviet-built weapons.

General R&D emphasis is concentrated in the areas of missile intercept systems, software analysis, sensor technology, materials research, and directed energy weapons technology. Specific areas of emphasis include:

- (1) Development and simulation of ballistic missile re-entry vehicle to Mach 7 at a 60,000-ft. altitude in cooperation with Technion, using a jet tunnel facility.
- (2) Conceptual design and component development for an anti-tactical ballistic missile defense system that operates at a speed of 2 km/second to engage re-entry vehicles at ranges of 500 km at altitudes of 100 km. Silo based missiles and radars would be used. The missile would be 3,380 mm long and 260 mm in diameter, weigh 250 kg and have servo-actuated fins for control, an infrared proximity fuse and a new radial warhead.
- (3) Center for military analysis with 30 scientist/engineers to provide assessments, vulnerability studies and strategy.
- (4) Image processing development including trackers, target detection, image understanding, target cueing, image compression and enhancement and computerized vision.
- (5) Optical coatings and filters including new processes and new materials for thin films, containing up to six different materials and over 40 layers in a single device. Equipment includes vacuum coaters with electron and ion beam guns, flash evaporators and microprocessor controllers.
- (6) Plasma detectors for microwave and millimeter wave length imaging arrays for possible application to space systems that could overcome microwave radiation, high-power lasers, and electromagnetic pulses.
- (7) Free electron lasers and intense relativistic electron beams, high-power RF and X-ray sources, pulsed power and high voltage systems, gas-puff Z-pinch for X-ray lasers, microfocus X-ray tubes.
- (8) Formal logic in specification and verification of software.
- (9) Composite materials technologies for structural bonded panels and laminates, ablative components, advanced rocket motors and truss structures.
- (10) Development of infrared, laser and electro-optical sensors. Special progress has been made in reducing the size and weight of radar sensors by moving to higher frequencies at 35 GHz and 94 GHz using advanced RF front ends with stripline antennas with built-in receiver functions.

- (11) Electronics and optronics for active target acquisition, identification, allocation and designation. This also includes signal transmission technologies over a wide spectrum using frequency agility, PRF agility in high resolution acquisition against low RCS targets. Passive threat acquisition using passive sensors such as infrared searchers and other electromagnetic sensors. A part of the technology is laser designation systems, laser beam concentrated energy and laser range measurements.
- (12) Anti-tactical ballistic missile defense system using mini drones with terminal sensors to destroy boosters and to engage re-entry vehicles at high altitudes.
- (13) Systems architecture and testbed for SDIO based on defense considerations in the terminal regime.

GENERAL

- o Rafael provides research and development support in a wide variety of areas for Israel's Ministry of Defense in Weapons Systems Technologies. More than 7,000 persons are employed at Rafael, with 35% of them scientists and 25% skilled technicians.
- o Major areas of business included missile developments such as Gabriel, rocket propulsion motors, a new fast-reaction anti-helicopter missile called Adam, with command line-of-sight guidance. The effort at Rafael, an acronym for Israel's Armament Development Authority, includes software development, artificial intelligence, composite materials and structures, and directed energy devices. Specific areas of research and development are:

CATEGORY I

- o Hypervelocity guided missiles for air defense/ATBM that cost less than \$1,000/kg. Reaction against Soviet-built SS-21, -22, and -23 ballistic missiles would be less than 5 seconds.

(ATBM, SATKA) - category

- o Area defensive systems employing a variety of missiles and drones, including the ATBM system. This is based on studies of the threat and available technologies by the military analysis center. The center is more battlefield oriented than technological and more critical than invention oriented.

(ATBM, SATKA)

- o Computer and software programs development with embedded systems, digital signal processing and algorithm development. A new command, control and communications center has been designed using fiber optics.

(BM/C³, OPTICS, C³) (See Attachment IX.)

- o Artificial intelligence applied to a navigation system using PROLOGUE and LISP language. A sonar system also is being developed using these languages.

(ELECTRONIC COMBAT, SATKA, BM/C³)

- o Computer aided software engineering where a magic square paradigm is being developed using Ada. This is in concert with two Israeli universities.

(BM/C³)

- o Formal logic verification of software for highly reliable routines. Related technology includes temporal logic artificial intelligence for workstations, with the first prototype being tested.

(BM/C³)

- o Image processing with understanding, cueing, compression, enhancement of target data. This has been combined with artificial intelligence for real-time application. In terms of fielding systems, this is the world leader.

(OPTICS, SATKA, BM/C³)

- o Edge/Centroid trackers with advances in related adaptive/area correlators being tested. This leading towards development of intelligent trackers that automatically identify targets and destroy them. This technology is based on pattern recognition and model-based target detection. It also has medical and industrial production applications.

(OPTICS, SATKA)

- o Plasma detection technology for microwave and millimeter wave imaging arrays that can withstand EMP and microwave radiation. This enables increased field of view, reduced radar scanning time and aids target detection.

(SATKA) (See Attachment VIII.)

- o High energy laser development including subsystems such as gas supply systems, combusters, and nickel technology. Pulsed UV excimer lasers are being developed for materials processing.

(SATKA, DEW)

- o Ballistics technology to develop explosively formed armor penetration warheads and hollow shaped charges with improved jets. Explosive reactive armor is included in this area of technology.

(TACTICAL MUNITIONS, ARMOR/ANTI-ARMOR, ATBM, KEW)

(This page left blank intentionally.)

RAFAEL PLASMA DETECTOR

Properties of a glow discharge plasma have been applied by Rafael to a sensor system to detect microwave and millimeter wave emissions. Inherent hardness in the sensor enables it to withstand nuclear weapons effects. The glow discharge plasma detector as depicted, operates at a few hundred volts with current densities between 10.5 and 10.1 amperes/square centimeter. A focal plane array can be constructed of glow discharge elements to image microwave/millimeter wave radiation. An electromagnetic wave illuminates the glow discharge tube, changing the voltage characteristics. These changes are reflected as a voltage charge across a load resistance, functioning as a video detector.



PLASMA DETECTOR

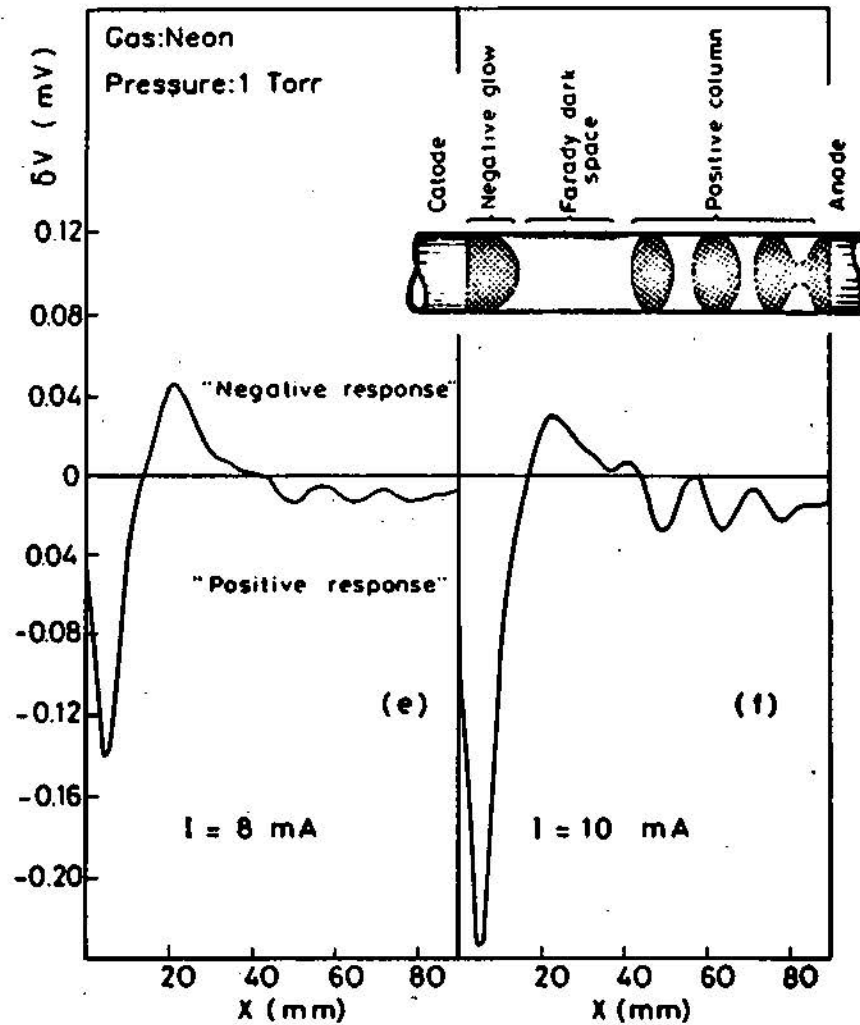

TYPICAL RESPONSE OF A GLOW DISCHARGE TUBE TO INCIDENT MILLIMETER-WAVES

III-43

RAFAEL SOFTWARE LOGIC

The methodology used by Rafael in developing software logic is depicted in the diagram as artificial intelligence generation tools, based on an automated computer design. Rafael uses formal methods based on mathematical logic for requirements specification. Recent developments in this area could provide significant improvement in software reliability. Advances include temporal logic for specifying and verifying concurrent programs, advanced workstations for software development, and AI theorem proving. Rafael has applied interval temporal logic to an operational software program.



SOFTWARE LOGIC

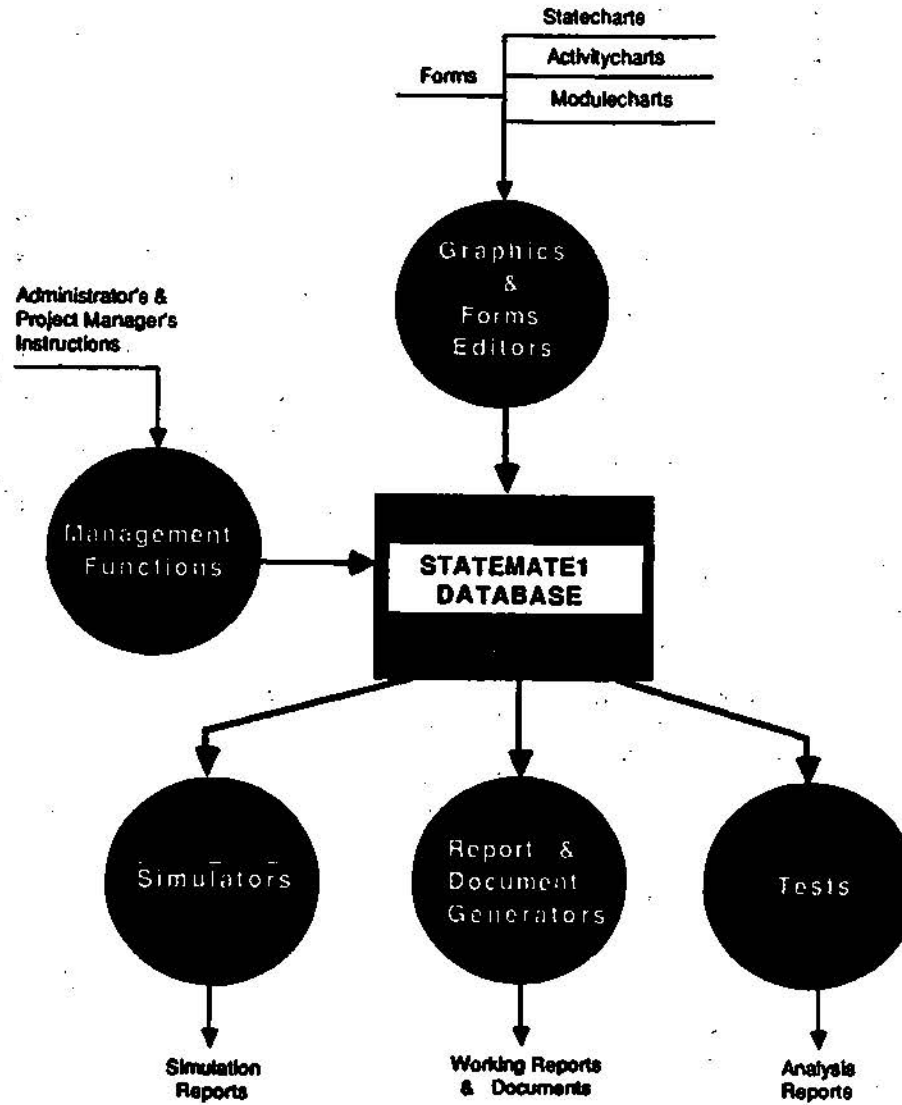

III-45

AI BASED TOOLS FOR SOFTWARE GENERATION

K. ELBIT

Elbit is a member of the Elron Electronic Industries Group with 1850 employees and an annual sales of \$150 million. About 75% of sales is export with 37% to the U.S.

In the avionics area, they are presently developing mission computers for the Israeli F-16 and the Lavi. They have embarked on a major update program for the F-4 Phantom as the integrator of the entire avionics system including a modernized HUD and radar system.

Elbit's tank fire control systems, originally designed for the Israeli Merkava tank, have been used to upgrade a wide range of tanks including the U.S. M-48 and M-60, the British Centurion, and variety of Russian tanks.

Additionally, Elbit produces command and control systems trainers as well as a line of digital communication units and artillery C³ and computational units.

Elbit has developed a method for digital representation of an image with applications to data compression and adaptive target recognition and discrimination. The approach holds promise for being a significant advance in these areas useful in both strategic and conventional applications.

They have developed a laser ranging device (ELDAR) making use of the retroreflection occurring in an optical seeker on a weapon to provide warning and location of potential threats. The device uses a highly sensitive receiver and may be on par with similar devices made in the U.S., but its photon noise limited receiver may provide extreme sensitivity.

ELDAR is used to provide passive correction of high energy lasers by measuring when the turbulence is zero and choosing to fire at that time. This roughly parallels more advanced work being done in a U.S. classified program.

GENERAL

- o Specializes in advanced avionics, airborne computers, fire control systems, communications, and command center ADP and display systems, some EW.
- o Growth areas involve thermal imaging systems and computerized machine vision.
- o Extensive interaction with U.S. companies (CDC, Fibronics, Inframetric's, Elscint)

CATEGORY I

- o Computerized vision - A technique for picture data compression up to 20:1 utilizing knowledge or eye/brain function. RPV capability for real-time targeting fighter aircraft. This is unique in the world.

(SATKA) (See Attachment X.)

CATEGORY II

- o ELDAR electro-optic location, detection, and ranging. Use of retroreflection from a threat optical device to warn of and locate the potential threat - uses a highly sensitive receiver design.

CATEGORY IIIA

- o **Passive correction of HEL's for turbulence (i.e., measuring turbulence and firing only when turbulence is zero).**

ELBIT DISCRIMINATION STAGE

The Elbit computerized vision discrimination stage diagram applies an algorithm for target features recognition and verification applying discriminate weights. The data obtained in this stage are boiled down to a discriminant number. If positive, it implies a target. If negative, it implies background. The sensor provides picture data compression up to 20:1, using techniques based on the function of human eye/brain.



DISCRIMINATION STAGE

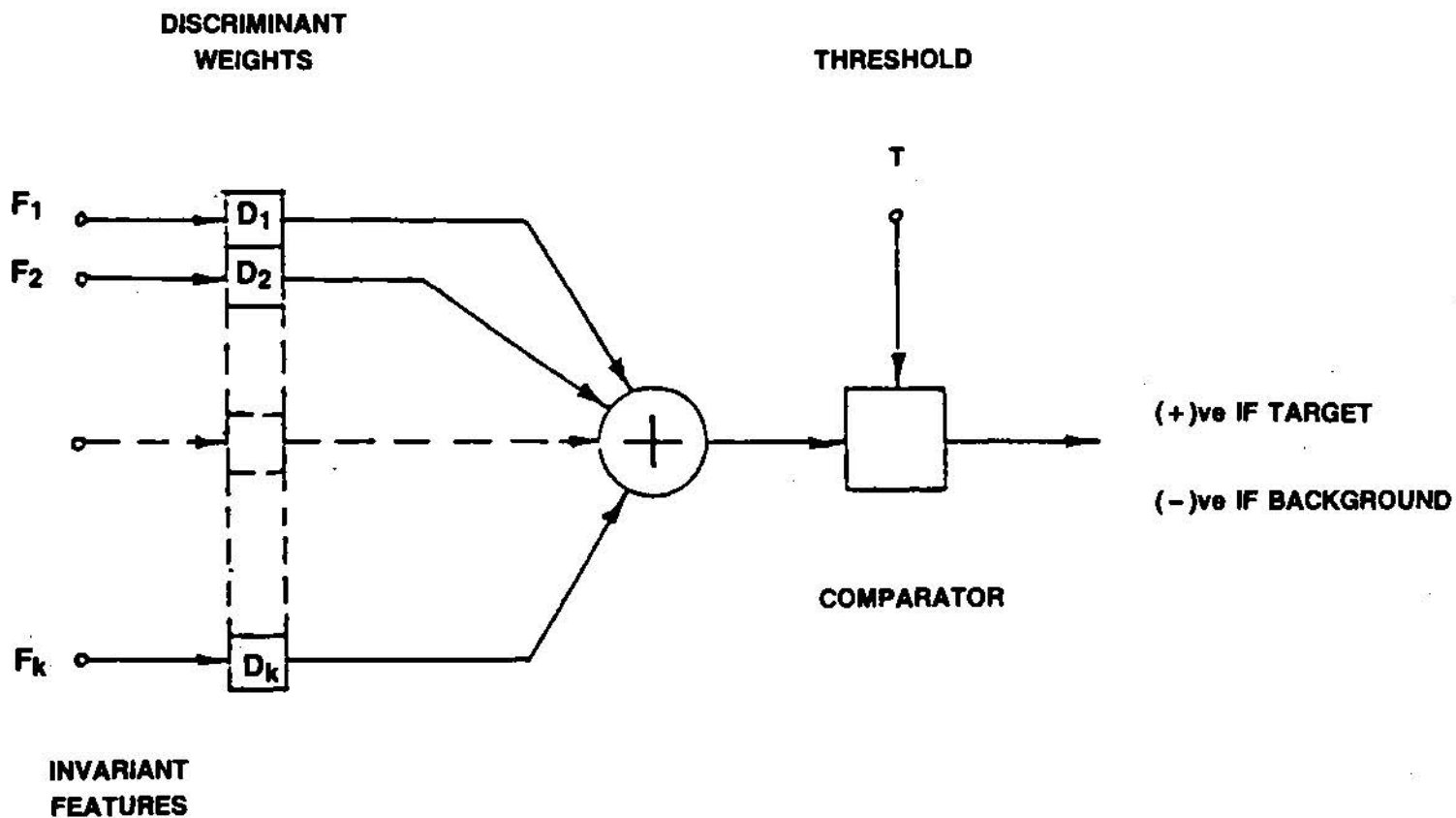

Algorithm for Feature Characterization and Target Verification

III-49

ELBIT ALGORITHM IMPLEMENTATION

The logic flow diagram depicts the algorithm used to determine feature identification of a signal. Applied to computer vision for a digital representation of image efficiency, data compression is provided. The algorithm is used to search for target areas of interest, mapping the field of vision into a set of characteristic transform coefficients, and pattern recognition by means of discriminant functions applied to the coefficients.



ALGORITHM IMPLEMENTATION

Logic Flow for Algorithm to Determine Feature Identification for an Input Signal

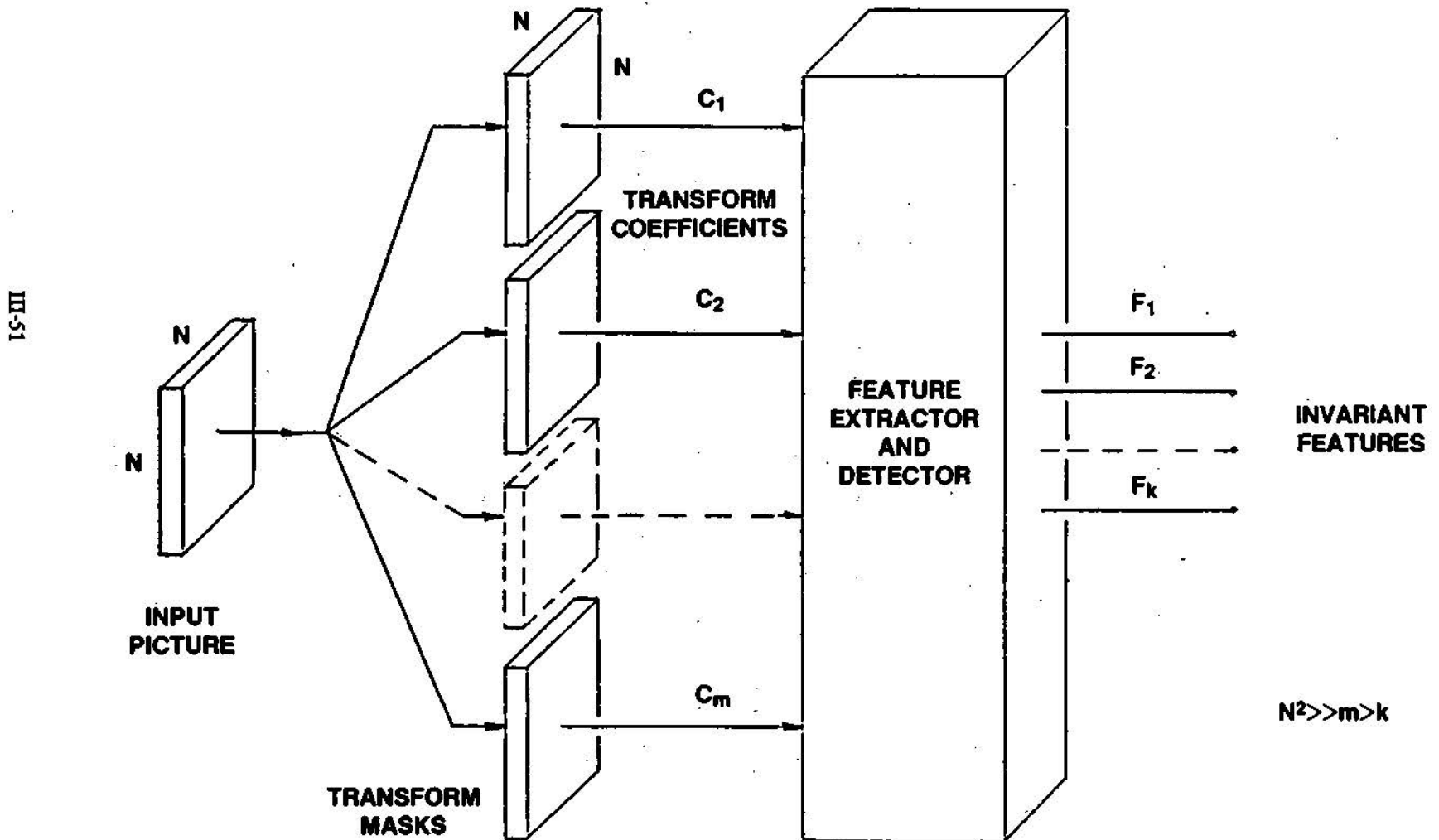

ELBIT DETERMINATION OF DISCRIMINANT WEIGHTS

The Elbit computer vision system is predicated on assigning a single discriminant number, based on a set of characteristics. The coefficients are derived from masks of the image related to how the human eye and brain process imagery and how a person searches for patterns. Note that the algorithm takes into account dimensions of color, motion and stereo; it does not distort the image and is invariant to rotation, position and size. This system has proved 98.5% effective in tactical target classification tests on drones.



DETERMINATION OF DISCRIMINANT WEIGHTS

Analysis of Factors Used to Verify a Target Classification

III-53

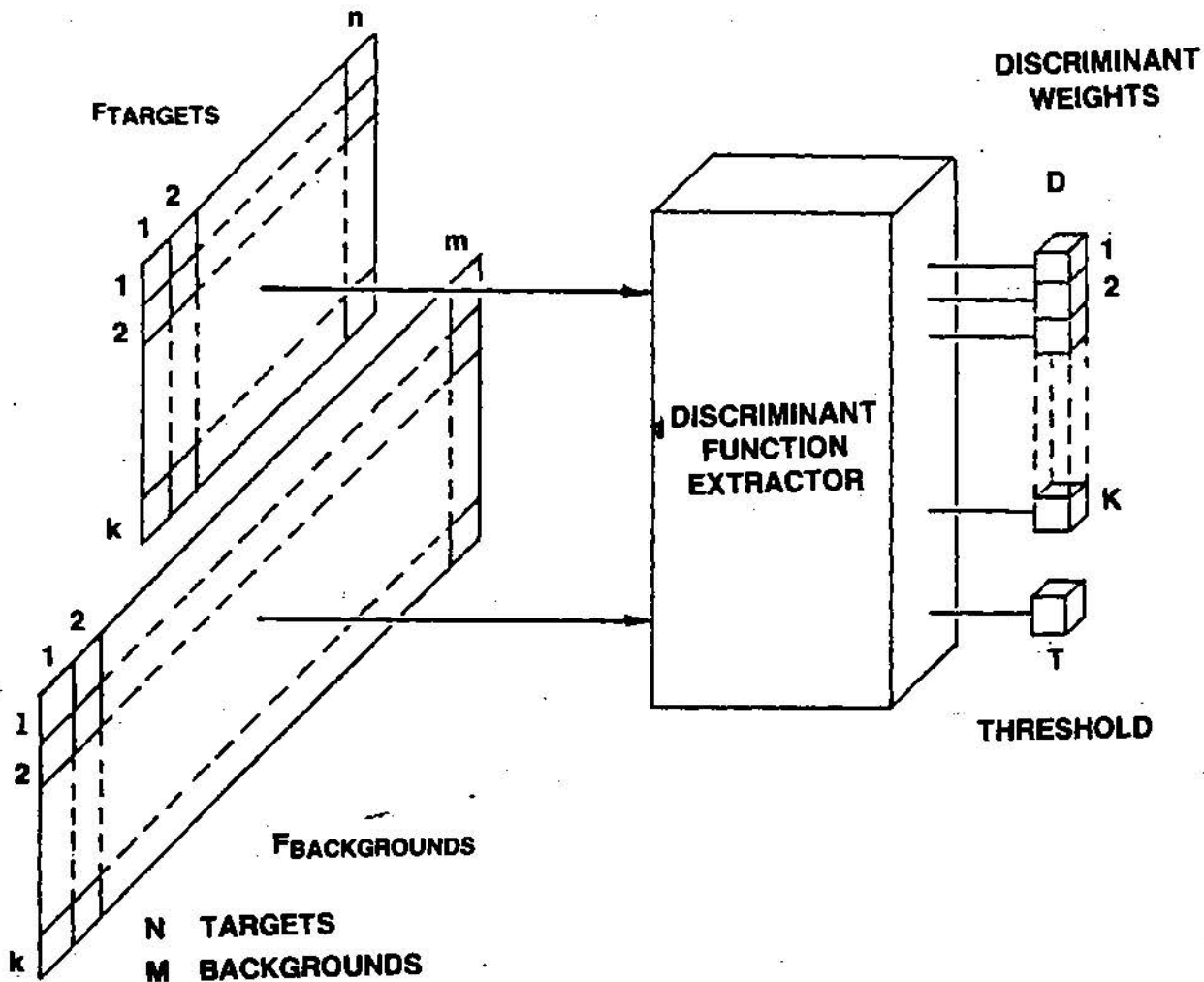

L. ISRAELI MILITARY INDUSTRIES

IMI is closely tied to the Israeli Ministry of Defense but operates as a private company with annual sales of \$568 million and 14,000 employees. Research and development funding is \$14 million (1986), and export sales are \$183.6 million. Major business development is in areas of weapons, ammunition, aircraft equipment, metal products and systems engineering. It is a leader in producing armaments for the U.S., other allied nations and Israeli defense forces, especially in anti-armor devices, warheads, fuses, propellants and rocket/missile systems. General R&D emphasis is in areas of explosives, aircraft weapons systems, aircraft self-protection systems, infantry weapons, anti-tank weapons, armored battle vehicles, artillery and guided projectiles, naval weapons systems and submunitions. Specific areas of R&D include:

- (1) Ramjet-powered hypersonic projectile that reaches speeds above 2 km/second for anti-armor applications.
- (2) Space reactive explosive ceramic armor developed in cooperation with Rafael. The technology can turn a penetrator rod sideways and halt its penetration. Approximately \$5 million per year is invested in this technology.
- (3) High-G projectiles with onboard guidance systems for air defense and possible ATBM defense.
- (4) Composite materials research for wide applications including rocket motor cases and projectile sabots.
- (5) Research for space-based kinetic kill vehicles that could have SDIO application, including a 40 pound rocket-powered device. The technology is believed capable of providing weapons with a velocity of 30 km/second that can sustain 200,000 Gs.
- (6) Advanced materials for space systems applications such as ceramics, refractories, and carbon-carbon.
- (7) Air breathing propulsion design and development work on systems such as scramjets and ramjets, and small turbojets.
- (8) Sensors, including electro-optics and laser beam riding technologies.

GENERAL

- o Israel Military Industries manufactures over 300 products, including weapon systems, ammunition and equipment for ground, naval and air forces. Products are used in over 50 nations, including NATO countries and the U.S.
- o IMI invests approximately 5% of annual sales in R&D activities. IMI operates 36 facilities and plants employing 14,000 people. Sales in 1984 were \$568 million, with \$183.6 million of this for Ministry of Defense programs, with export sales of \$321 million.
- o General R&D is under a central laboratory developing a line of advanced munitions - with over 50% of the company's product lines developed by the laboratory -- Tank and motor ammunition, extended - range artillery ammunition, submunitions, ballistic protection armor. Specific areas of R&D emphasis are:
 - laser seekers and microelectronics for missiles and artillery ammunitions.

- tank gun ammunition such as the 105 mm APFS DS-T armor piercing, spin stabilized, discarding sabot tracer round effective against spaced armor using a swaged tungsten alloy core.
- hypervelocity medium caliber rounds, anti-tank systems and ramjet powered kinetic energy penetrators.
- chemical propellants and explosives including RDX, HMX, PETN explosives and single, double and triple base solvent and solventless extended propellants.
- command, control, and communication including digital communications, data links displays, control centers and systems.
- aircraft weapons systems such as air launched decoy systems, 25 mm guns, cluster bombs. Self-protection systems, runway penetration bombs.

CATEGORY I

- o Material for kinetic energy penetrators -- tungsten based heavy metal and other alloys using cold isostatic pressing and centering techniques. Research yielding improved alloys through plastic deformation and heat treatment that provides 17.15 G/CC, tensile strength 225,000 PSI, tensile yield of 220,000 PSI (0.2% offset), elongation of 8% in 1 inch.

(TACTICAL MUNITIONS, ARMOR/ANTI-ARMOR, KEW)

- o SDIO technology development, mostly for high endoatmospheric devices--propulsion, structures, warheads, and fuses. Other applications include space-based rockets, a 40 pound kinetic kill vehicle, light motor cases, nozzle and thrust vector control.

(SATKA, KEW)

- o Rotating solid rockets, hypervelocity high-G projectiles/rockets (30 km/second, 200,000 G potential).

(KEW)

- o Warheads -- hollow charge, self-forging fragments. Totally revolutionary technology.

(TACTICAL MUNITIONS, KEW)

- o Research on a kg-class projectile that will travel at 2 km/second using ramjet power. Limited data exchanged with U.S. companies. Ability to accelerate large masses exceeds any known U.S. effort.

(TACTICAL, ARMOR/ANTI-ARMOR, KEW)

- o Development of spaced armor; working on reactive armor programs with small explosive charges jointly with Rafael to stop armor penetrators and hollow shaped charges. The U.S. urgently needs this technology.

(ARMOR/ANTI-ARMOR)

- o IR missile detection system: gyro, cooler and dewar with a 10 year shelf life, high (10,00) G., spins up in less than 1 second. No one else has ever come close to achieving these acceleration levels.

(TACTICAL MUNITIONS, SATKA)

- o Advanced materials for space systems applications -- ceramics, refractories, carbon-carbon. This is superb structural material.

(SATKA)

CATEGORY II

- o Low cost solid propulsion.
- o Air breathing propulsion research and design work.
- o Electro-optics and laser beam riding weapons applications.
- o Fuses -- electronic proximity and time.
- o Thermal imaging -- imaging processing for target identification.
- o Aerodynamic design -- missile, projectile, and airborne platforms.
- o High-G environment -- cannon fired projectiles.
- o Airborne autopilot system -- missile, projectile, and airborne platforms.
- o Delila jet propelled multi-purpose ground and air launched missile with speed to 0.8 Mach, payload to 50 kg, equipped with total digital autopilot.
- o Cannon launched anti-armor maneuvering projectile (CLAMP), a semi-active laser homing 155 mm anti-armor projectile, hardened to 10,000 plus GS, ballistic and glide modes to 20 km range, hollow charge warhead to penetrate 800 plus mm.
- o Man Portable Anti-Tank System (MAPATS), an EO beam rider missile with a 4,500 meter range. Laser source is a semiconductor GaAs laser operating at 0.9 micrometers coupled into a fiber rod. A 1:10 zoom system using the same stepper motor and cam. The visible and part of infrared optics are incorporated into one channel.
- o Rocket systems such as the LAR-160 mm with 30 km range for use with conventional or radar fire control; 240 mm artillery rocket with 10.5 km range and submunition cluster warheads; MAR-290 mm rocket with 70 km range; 82 mm air-to-ground rocket; B-300 man portable anti-tank rocket produced in the U.S. by McDonnell Douglas as the SMAW/B-300 for the Marine Corps. U.S. testing IMI light artillery air transportable.

M. TADIRAN

Tadiran's 1985 sales reached \$570 million, roughly half is due to exports to some 52 countries. In 1985, they had \$65 million worth of R&D, 80% of which was invested from profit. The company is 70% owned by KOOR, the industrial arm of the trade union organization; 19% by GTE, and 11% by the employees. Their sales to the U.S. doubled in the past year with sales of the VRC-12, the mini-RPV to the Navy.

They produce a broad range of tactical communications equipment in the HF, VHF, and UHF bands, perhaps the most comprehensive product line of any single manufacturer. This includes security, frequency hopped anti-jam, as well as adaptive HF. Their tactical electronic warfare equipment is also capable and extensive, including ELINT, COMINT as well as jamming equipment.

In all of this equipment, they make extensive use of the integration of SAW devices into hybrid circuits for signal processing at RF. They use SAW's with TW product of up to 2000 in Mil Spec devices. An extensive discussion of Tadiran's capability in the communications and EW area is included in the Appendices.

The Mini-RPV system, (a joint venture with IAI), is a very capable and flexible system that has been extensively combat proven. The U.S. Navy has contracted for a 20 A/C system with an ELINT/EO payload.

Several proposals submitted by Tadiran were judged by the team to be rather theoretical and either not on a par with U.S. or other efforts or insufficiently described. The proposal on the Detection of Missiles Launches via Ionospheric Sounding is rather theoretical in nature, whereas the U.S. has extensive research and operational experience with such systems. A U.S. Air Force tactical warning system (440L) using these concepts was terminated some years ago because of its poor reliability and high cost relative to value. The intelligent Target Discriminator and Multi Point Sensors Discriminator proposals were too vague and insufficiently described to make a good judgment.

GENERAL

- o Tadiran is a privately owned company producing a broad range of communications, electronics, and electro-optic equipment of which roughly one-half is export. 19% of the shares are owned by GTE.

CATEGORY I

- o Produces a range of tactical communications equipment which is as or more advanced than fielded U.S. equipment.

(C³) (See Attachment XIII.)

- o Highly capable, MIL SPEC SAW devices of code length (TB product) of 2000 or more, which can be electronically programmed for frequency hopped communications, signal processing and radar. Off the shelf.

(ELECTRONIC COMBAT, BM/C³)

CATEGORY II

- o A 20 A/C RPV system with 3 ground stations, ELINT package (0.5 - 18 GHz, 0.5 degrees DOA) and night vision package, 9 hours on station at 12,000 feet (with IAI).

CATEGORY IIIA

- o **Detection of missile launches via ionospheric sounding (proposal).**
- o **HgCdTe IR focal plane array development.**

CATEGORY IIIB

- o **Intelligent target discriminator, the use of AI/expert systems for target discrimination (proposal).**
- o **The multi point sensors discriminator which identifies decoys by means of their 3D structures and features (proposal).**

(This page left blank intentionally.)

TADIRAN CORRELATOR/ENCODER

Block diagram provides the function flow of a single pulse analysis circuit that permits pulse compression using Surface Acoustic Wave (SAW) technology. A matched filter is used as an optimum detector to correlate the incoming signal with a stored reference to overcome noise and jamming in spread spectrum communications for detection of the transmitted signal. The matched filter also can serve as a phase coded waveform by applying an impulse to the filter input. The correlation signal from the matched filter can be used for rapid synchronization acquisition and data demodulation, precision ranging, radar pulse comparison and signature comparison/identification.

TADIRAN

Function Flow of a Single Pulse Analysis Circuit Allowing Pulse Comparison

BLOCK DIAGRAM

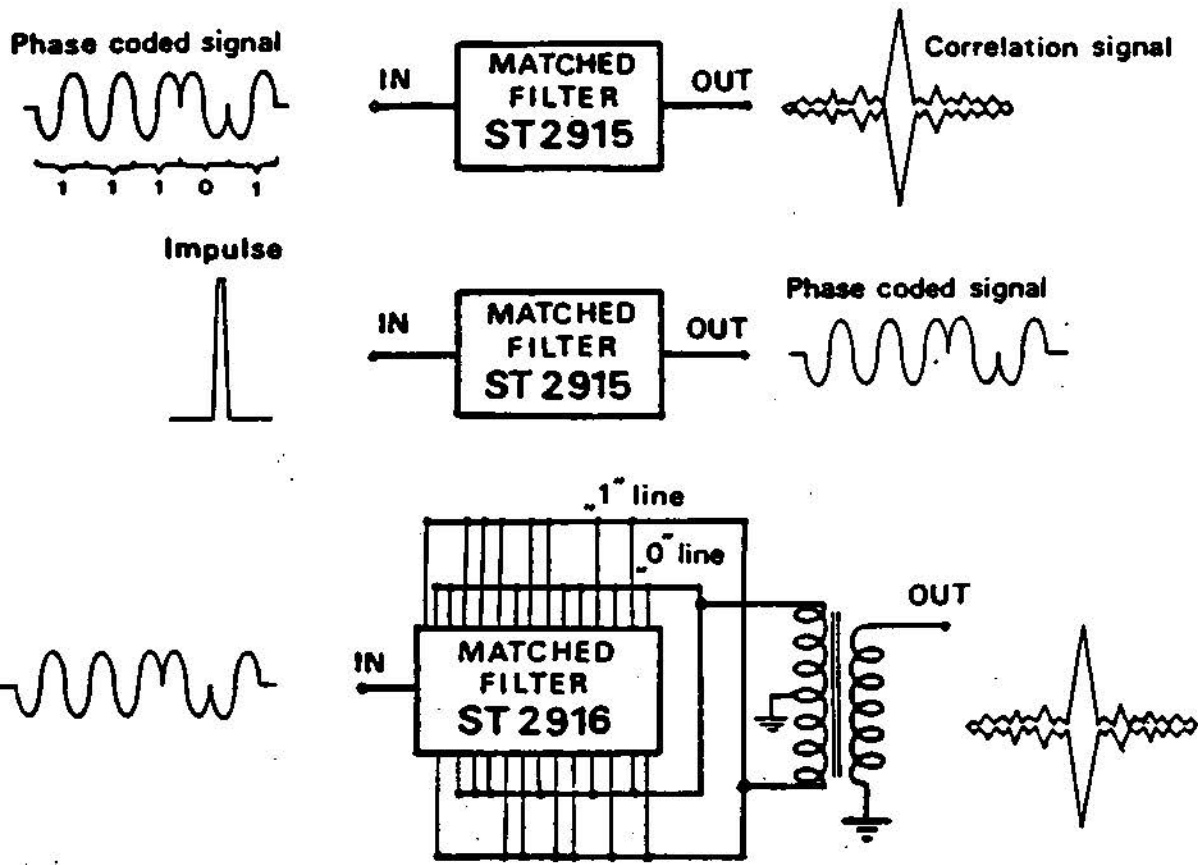

III-61

FEATURES

- Small size
- High reliability
- Good reproducibility
- Temperature stability
- Wide dynamic range
- Simple operation
- Operation at I.F. frequency
- Moderate bandwidth

PSK CORRELATOR/ENCODER

TADIRAN RECEIVER SYNCHRONIZATION BLOCK

Tadiran's typical application diagram is used to depict target signal analysis. The Israeli company is oriented towards development of custom made Surface Acoustic Wave devices. Fixed code and electronically programmable matched filters for PSK and MSK waveforms up to a length of 30 microseconds at moderate hit rates are provided.

TADIRAN

TYPICAL APPLICATION

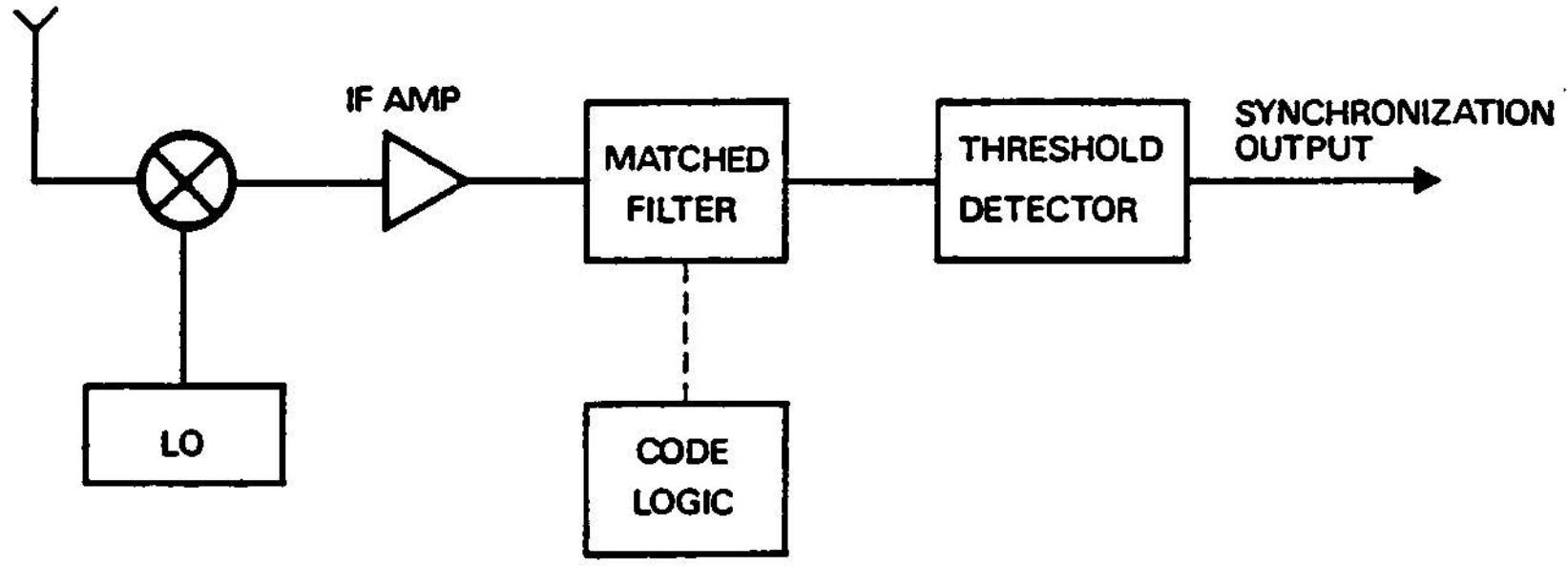

III-63

Receiver Synchronization Block

Target Signal Analysis

TADIRAN CORRELATION IN SAW MATCHED FILTER

Tadiran's typical bi-phase Surface Acoustic Wave (SAW) matched filter is illustrated in the schematic diagram. The application of the RF signal to the filter input generates an Acoustic Surface Wave which propagates from the input to the output transducer. Applications of a narrow pulse to the input results in the PSK waveform at the output. The waveform is phase coded according to the output transducer geometry. A time reversed replica of this signal applied to the input results in a correlation peak.

TADIRAN

OPERATION

A typical bi-phase SAW matched filter is illustrated schematically

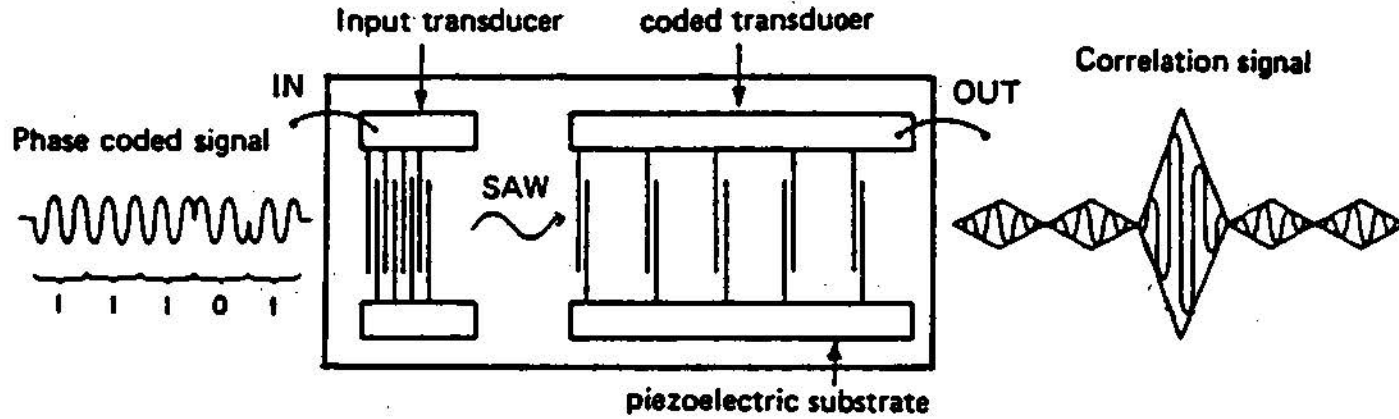

III-65

Comparison Capability for Single Pulse

CORRELATION IN SAW MATCHED FILTER

CAPABILITY ASSESSMENT FOR ISRAEL

√ indicates Category I capability

	CONVENTIONAL					ATBM	SDI-RELATED			
	TACTICAL MUNITIONS	ARMOR ANTI-ARMOR	OPTICS	ELECTRONIC COMBAT	C ³		SATKA	DEW	KEW	BMIC ³
SOREQ	√	√	√			√	√			√
EL-OP			√	√				√		
IAI				√		√				√
ELISRA			√				√			
HEBREW UNIVERSITY			√				√	√		
RAFAEL	√	√	√	√	√	√	√	√	√	√
ELBIT							√			
IMI	√	√					√		√	
TADIRAN				√	√					√
ELTA										
ISRAEL OVERALL	√	√	√	√	√	√	√	√	√	√

99-III

ATTACHMENTS

- I. Introduction
- II. Lead Azide Laser - Negev
- III. Electro-Thermal Acceleration - SOREQ
- IV. HgZnTe IR Detectors - SOREQ
- V. El-Op
 - A. Gelatin Holographic Optical Element
 - B. High Power Sealed CO₂ Laser
- VI. Wigglerless Free Electron Laser - Hebrew University
- VII. Excimer Kinetics - Hebrew University, Racah Institute
- VIII. Plasma Detectors - Rafael
- IX. Software Logic - Rafael and others
- X. Computer Vision - Elbit
- XI. Electronic Warfare
- XII. SIGINT - Octopus
- XIII. Tadiran
 - A. EW/DF and Emitter Location
 - B. C³I
 - C. EW, COMINT, COMJAM, and ELINT
- XIV. Lavi Electronics - Elta
- XV. Airborne SIGINT
- XVI.
- XVII.
- XVIII.
- XIX.
- XX.
- XXI.
- XXII.
- XXIII.
- XXIV.
- XXV.
- XXVI.
- XXVII.
- XXVIII.
- XXIX.
- XXX.
- XXXI.
- XXXII.
- XXXIII.
- XXXIV.
- XXXV.
- XXXVI.
- XXXVII.
- XXXVIII.
- XXXIX.
- XL.
- XLI.

Attachment 1

INTRODUCTION

This section contains a series of unclassified, nonproprietary, and open literature summaries of science, technology and weapons systems developments which the team collected during its visits to various companies and laboratories.

These summaries contain data that include:

- o Comparisons between U.S. and Israeli electronic combat systems.
- o Science and technology comparisons.
- o Armor and anti-armor comparisons.
- o Category I technology summaries -- unique and different, technologically sound items.
- o Corporate/laboratory overviews where technological advances exist.
- o Physical and engineering data on technically advanced programs in an original format provided by allied organizations.
- o European laboratory technology assessment.

More specific physics and engineering data are provided as proprietary technology in a limited distribution Proprietary Book 2, Volume 1 and 2, to support the assessment conclusions of the team members.

Attachment II

CATEGORY I ITEM: LEAD AZIDE, SHORT WAVELENGTH CHEMICAL LASER - NEGEV

NEGEV has devised some interesting and innovative ideas for pageroducing short wavelengths, the so-called solid fuel pulsed chemical lasers. They claim that they may be able to get as much as ten kilojoules per pulse in the blue-green (462 nm).

This device has considerable interest as a possible easily deployable rocket-launched optical "bellringer". Ten kilojoules in the blue-green will enable these kind of individual pulse energies to penetrate into the ocean to a depth of 3,000 feet over an area of 10,000 square kilometers (a square 100 kilometer on the side). Relaxation of the depth requirement (US submarines do not normally cruise to that depth) could lead to coverage of as much as 1 million square kilometers down to 1,000 or 1,500 feet. Should this kind of laser prove feasible, it would be possible to launch a laser of this type on warning and have it radiate over very large areas to considerable depths with a single intense optical pulse. This pulse would alert the submarine to come to periscope depth or whatever prearranged EAM procedures are required. This is, therefore, of interest in the deployment and command and control of our strategic submarines. Since the weight of such a device involved is small (perhaps one pound of lead azide required to provide a 20 kilojoule pulse) the system could be modular with the F15 launched ASAT system, and deployed to an altitude of some 2,000 or 3,000 kilometers, then be allowed to shine down on the ocean. The requirements of more

Attachment II

than 1 million square kilometers may be too stringent since the holding areas are probably smaller than at 1 million square kilometers in area.

The idea is a derivative of techniques which were used in the past 5 or 10 years to produce intense CO₂ radiation in a detonating mixture. The first chemical laser, based on the reaction of hydrogen (or deuterium) with chlorine and fluorine, was carried out some 15 years ago by Pimentel and Kaspers at the University of California, Berkeley. It was proposed that one could take the reaction of various materials with metals and produce excited states of metal oxides in the gas phase. One of these reactions, as cited in the SOREQ report, was the reaction of barium with nitrous oxide. However, none of these approaches has proved fruitful; in fact none of them has worked. Another reaction proposed was the reaction of nitrogen fluoride with iodine fluoride to produce a transfer chemical laser. This has also been unsuccessful. Previous research has centered around continuous wave lasers. One of the problems here is that the reaction rate will always be limited by diffusive mixing as the reactions described here are diffusion controlled chemical reactions. Other schemes in which excited states of nitrogen are utilized have not proved feasible because of the deactivation process occurring in the collision of nitrogen molecules.

The Israelis, however, have devised an extremely clever approach to solving the many problems associated with the production of short wavelength light: chemical pumping. The reaction they have proposed is the detonation of lead azide. This produces lead and two and three radicals which then decompose to form an excited nitrogen molecule and

Attachment II

two de-excited molecules. The excited nitrogen molecule (upon collision with lead) activates the lead and in turn is deactivated. The activated lead has a lifetime of 11 milliseconds. They point out that population can be built up over a time much shorter than a lifetime, in fact over the time of detonation of lead azide which is a time like one microsecond. Since the detonating lead azide is a homogeneous medium, no mixing is required to produce the reaction; therefore, the reaction is not diffusion limited. There appear to be no scientific reasons why this scheme should not succeed. Other azides have also been proposed besides just copper; magnesium, cadmium, and aluminum. The investigators proposed to initiate their work with lead, which appears to be the best understood of these lasing transitions. This is also convenient because the 462 nm line is so close to the maximum penetration wave length of the ocean. ("The Jerlov Minimum")

Various schemes have been proposed to generate a medium with the active lead atoms. Granting our conclusion that there are no scientific reasons why this scheme will not work, the principal problems seem to be how to physically arrange the detonating material. Should small amounts be detonated and allowed to flow into the chamber, can large amounts of lead azide be detonated at high pressure? These questions must be answered in a practical design of the laser.

It would appear that this is an ideal project for collaborative interaction with the Los Alamos National Laboratory (LANL). It involves various aspects of shock waves, gas dynamics and quantum electronics of the M6 and M4 groups and the shock tube group at

Attachment II

Los Alamos, as well as the laser group. Livermore would also be a good candidate; however, Livermore does not have a shock tube group that is dealing with issues involved in the handling of the detonation products which are hot gases coming from the detonation.

This is one of the more ingenious and useful ideas we encountered during our European tour. A copy of the proposal is attached.

Attachment III

CATEGORY I ITEM: ELECTRO THERMAL ACCELERATION - SOREQ

The maximum gun projectile velocity obtainable by conventional means is about 1 kilometer per second. This value is limited by the burning rate of the propellant, the sound velocity in the propellants, and in the length of the barrel. One tries to use light atoms such as the light gas gun, and pre-compress (or heat) the light gas as in the two stage light gas guns. Here projectile velocity of seven or eight kilometers per second can be obtained with masses of 20-to-30 grams. Another approach is to control the propellant burning front wave by electric means or actually heat the propellants by electrical energy sources. In the plasma heating technique an electric discharge takes place between a solid cathode through a hollowed out cylindrical cavity in CH_2 or some other type of propellant. The temperatures and pressures attained would be on the order of several eV and several kilobars. The plasma jet produced interacts with a light fluid propellant which can be water, propane or some other light substance. The plasma flowing out of the end of the cylindrical tube discharges through a supersonic nozzle and its velocity is then several tens of kilometers per second. This hot plasma jet interacts with light fluid mentioned above and stagnates. The mixing and heat exchange between the fluids increases the base pressure and accelerates the projectile. A rectangular pressure shape can be obtained by tailoring this charge. The acceleration can be extended to very high velocities because the sound velocity

Attachment III

in the vaporized accelerating medium is large compared with that of the propellants. This is a result of the high pressure and temperatures achieved.

The other projectile concept ongoing in SOREQ is the base acceleration of a projectile by attached propellant. This scheme is also being examined in French and German laboratories. The SOREQ personnel used combined electrical and chemical energy sources. In this technique various schemes can be used to contain propellant around the edge of the projectile, protecting the walls of the barrel. Both electrical and chemical energy sources are used. The plasma jets discharging at very high velocity ablate the charge and increase the propellant burn rate along the projectile base. This thrust is enhanced as a result of terminal pressure in the closed barrel. Only preliminary analysis has been done using these techniques, and they have made no claims as to the maximum projectile velocity they can obtain. They do emphasize the utilization of various components of available hardware, such as a 50 caliber rifle barrel with a breech assembly compatible with both the plasma injector and the platform on which it is mounted.

These ideas seem very fruitful, but they have not been developed in a sufficiently detailed way. Again, collaborative plans should be started with BRL and the Los Alamos Laboratory using hydrodynamics and detonation codes. This work should also be integrated into the work done elsewhere in Europe. The paper describing this work follows.

Attachment IV

CATEGORY I ITEM: THE USE OF Hg Zn Te IN IR DETECTORS - SOREQ

Among the most promising materials for IR detector are two-six compounds which the semi-metal mercury telluride that can be tuned to yield a semi-conductor with a band gap that vanishes at an intermediate alloy composition. By utilizing this effect it is possible to obtain narrow depth semi-conductors for IR detectors. The mercury cadmium tellurides have been studied extensively because of their high performance photoconductive and photosensitive capability. Unfortunately, the set of mercury cadmium telluride compounds are unstable. It has been shown that the mercury telluride bond is destabilized by alloying it with cadmium tellurides; on the other hand, the bond is stabilized by the addition of zinc. The growth of single crystal solid solutions of mercury zinc telluride was first reported in Applied Physics Letters 1 January 1985 by the SOREQ group.

The scientific paper involving the testing of mercury zinc telluride, pictures of the moiré quality of the epitaxial layers, the so called "rocking chair"; in general, overall performance is discussed thoroughly in the attached references.

It is clear that mercury zinc telluride appears to be a superior material. However we must now test actual detector arrays in various geometric configurations. As this new material appears capable of replacing currently proposed detector material, there should be an active program initiated in collaboration with a university, Bell Labs or some corporate entity to place the mercury zinc telluride crystals

Attachment IV

in various kinds of arrays. In this way performance can be monitored in a practical way. See attached References.

1. A. P.

2. B. P.

EL-OP

El Op is an electro-optical systems house developing, designing and manufacturing, with a concentration on advances in technology in a number of areas that could be utilized by the Strategic Defense Initiative Organization, and Defense Department Research and Engineering in tactical weapons areas. Technology developments include:

- o **Helmet Display System (HDS):** The HDS is based on an electro-optic device which senses the pilot's head position and permits the pilot to slave onto a target with the display and sighting system.

- o **Non-recycling CO₂ laser** that can increase average power by an order of magnitude by continuously exciting the sealed off lasers for energy extraction based on coaxial configuration designs to remove heat. Functioning at a few kilowatts of power, the sealed-off laser can be used to detect decoy signatures, measure velocity and blind sensors.

- o **Holographic retro-reflectors and beam transformer** operating in the visible to near infrared (0.41, 1.3 and 2.7 microns) in a very lightweight and compact system with strong aspherical properties.

Attachment V

- o Solid state Nd:YAG and Nd:Glass lasers operating in the visible and ultraviolet at near diffraction-limited divergence at relatively high average power of 20-90 W at the various wavelengths. The application could be for SDI surveillance and tracking of space targets. The technologies involved include slab-pumping, phase-conjugation, harmonic generation and beam cleanup by stimulated Raman scattering.

- o A laser radar system using new concepts and components. The system is frequency stabilized, compact and sealed-off transceiver for high coherent detection.

- o A new concept in stabilized heterodyne/homodyne systems for active imaging, Doppler velocity sensors, tracking sensors and laser radars.

EL Op also specializes in other types of laser systems and they have a fairly substantial capability in various areas of laser physics. The latest system to be investigated by EL OP is a solid state laser that will operate at 416 nm at 50 pulses per second. This wavelength is obtained by Raman shifting to a 3rd harmonic which yields a lift of 355 nm. The Raman conversion takes place in a gas cell containing the Raman active medium. The project goal is a 30 watt output average power at 416 nm with a fraction number of comparable divergence. The basic technical and scientific exploration has been proven in other areas: the slab laser technique was developed and

Attachment V

utilized at Livermore 10 to 15 years ago. Much of the recent Raman work by Komine, Mani Bhaumik, and Eddie Stappaerts at Northrop is somewhat further advanced in theoretical understanding. El Op may have advantages in the packaging and the implementation into an overall system of this kind.

CATEGORY I ITEM: GELATIN HOLOGRAPHIC OPTICAL ELEMENT - EL OP

Based on the properties of gelatin, the technology of the gelatin holographic element is not angle dependent and can provide replacements for lenses, prisms and spectral filters. EL OP is using this technology with computer-generated holography and is developing holographic optical elements outside the visible part of the spectrum.

The holographic optical element technology is a field that is expanding rapidly in applications. One possible application proposed by EL OP is for IFF use, since the thin film gelatin is highly selective in wavelength, and avoids the three apex lines with high accuracy of the deflection angle maintained. Another application is stealth in the visible or IR regime.

EL-OP has specifically applied this technology to a Helmet Display System which increases the combat pilot's first-shot time line by focusing accurately on the target and allowing a complete freedom of head movement.

The HDS measures line of sight to target relative to a reference frame. It processes this information for use in target acquisition and control weapon delivery system and remote sensors.

The stabilized display symbols remain in space and move into the scene or out of it as the pilot shifts his line of sight.

* HOEs are flexible to geometrical constraints.

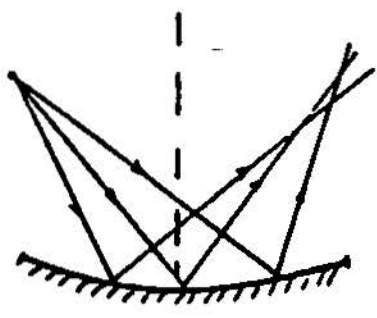

conventional

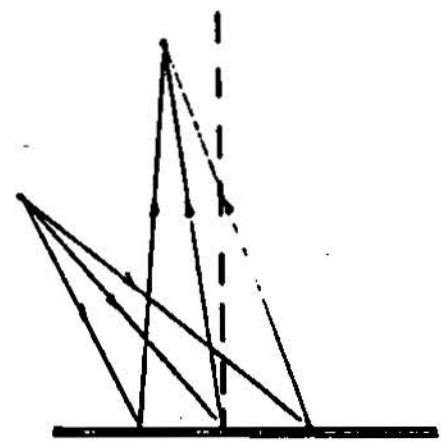

HOE

To first order, a HOE is not affected by the shape of the substrate.

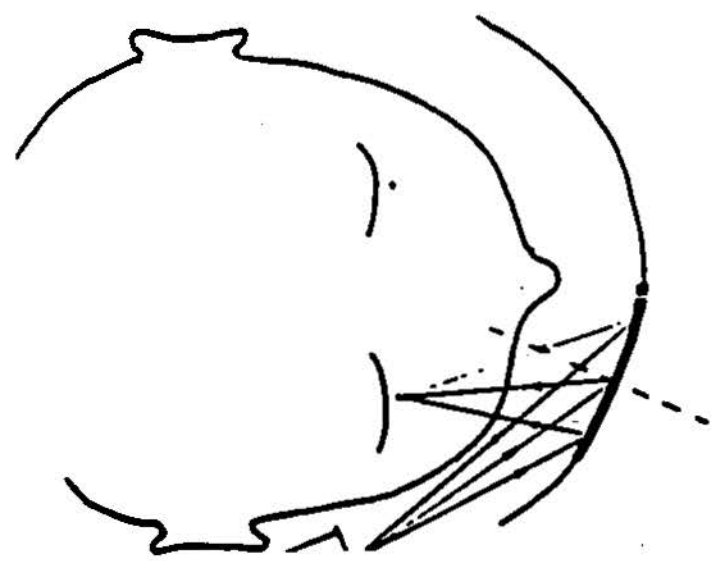

* Multifunction components

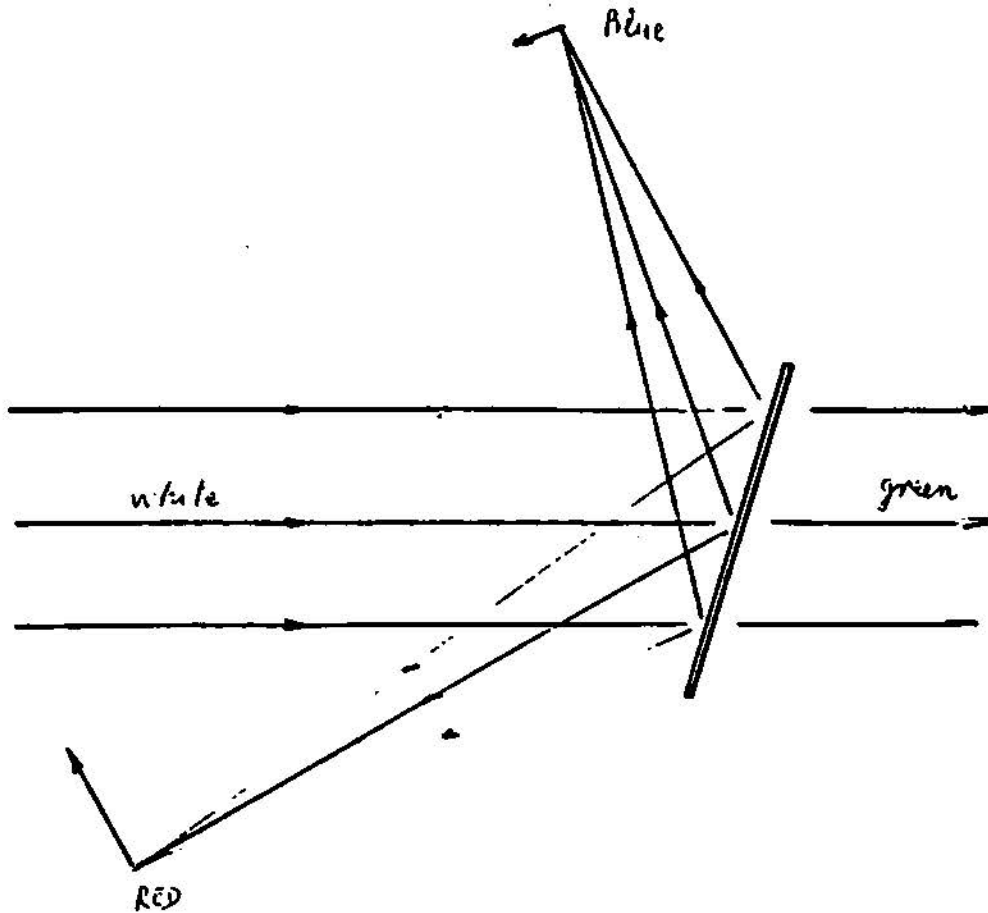

A single HOE can be used to replace lenses
prisms and spectral filters.

Spectral & angular selectivity

Spectral response of a HOE:

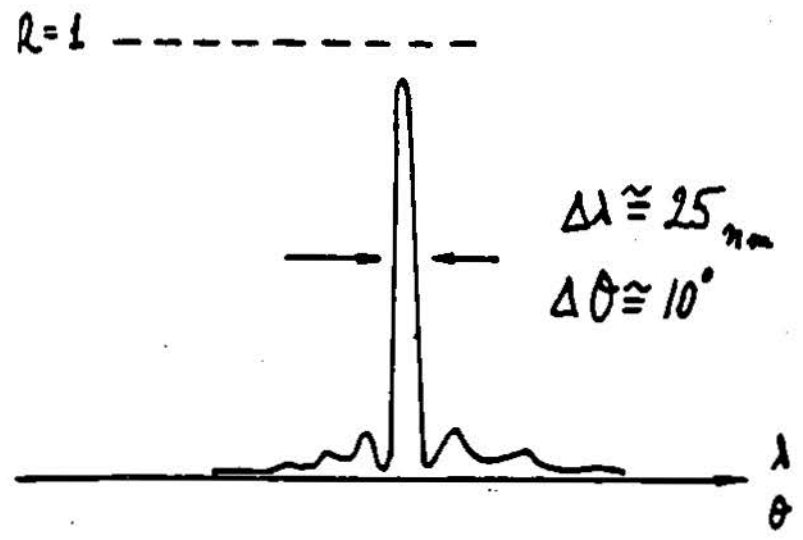

"See-through" response:

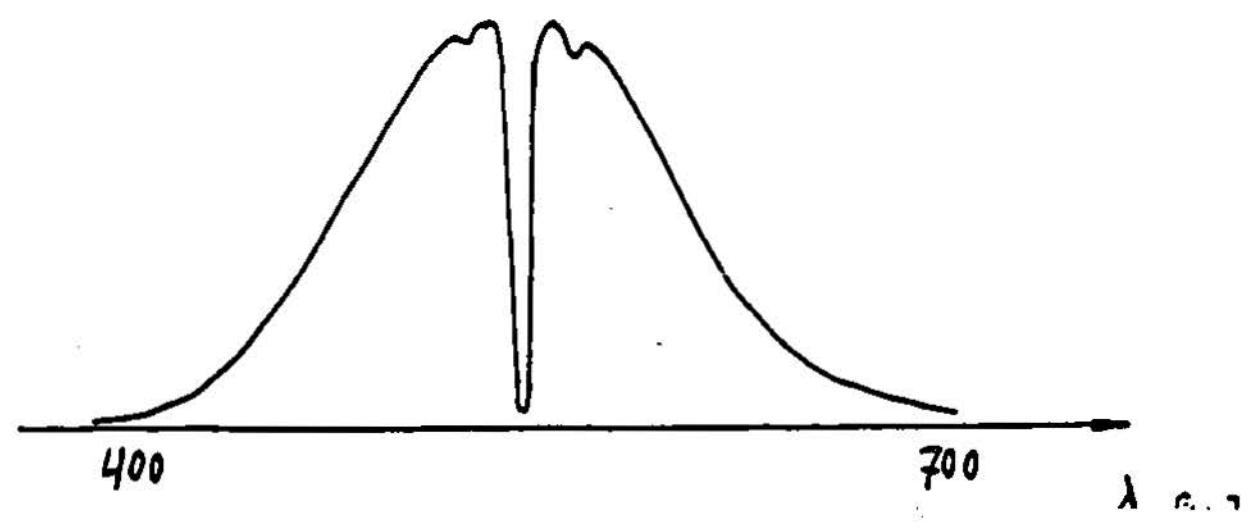

CATEGORY I ITEM: HIGH POWER SEALED OFF CO₂ LASER - EL OP

High powered CO₂ lasers normally extract heat by conduction through the cavity wall and then to a gas which is removed from the cavity. This is necessary because of thermal effects that reduce the efficiency of the laser. El Op has developed a scheme in which the cavity is designed with a four pass system which is cylindrically symmetric. The length of the cooling surface can be extended, and the sides of the cylindrical shells can be cooled more easily. The improvements achieved by this technique are increased power per unit length and a more stabilizing frequency with more controlled temperature effects. This sample sealed off laser was set to operate at 4 to 5 kilowatts continuously. It is planned to be upgraded and has potential for improving the laser radar currently under development at El Op.

Attachment VI

**Category I Item: WIGGLERLESS FREE ELECTRON LASERS -- HEBREW
UNIVERSITY**

Scientists working at the Hebrew University of Jerusalem, Yale and the Office of Naval Research have come up with an interesting scheme to construct a free electron laser without a wiggler, using a "two beam" accelerator. This possibility was also studied theoretically, although without reference to specific beam sources, by the Frascati group.

These investigators propose abandoning the use of wigglers for stimulating optical emission from a charged particle beam, and propose instead a two-stage accelerator approach based on using magnetic fields. This is shown in Figure 1 of the attached paper.

As shown in Figure 1 electrons are introduced from the accelerator at an energy of 2 MeV and a current of 3 kiloamps. They are introduced at an angle to the two magnets so that a spatially coherent helical orbit can be produced for all the electrons. 0.5 mm radiation is coupled from stage one to stage two to serve as a driver for the autoresonant accelerator in stage two. The radiation is focused into a tapered light pipe for acceleration and efficiency in focusing. In this arrangement the compact device can produce 10 MeV electron beams. In the first stage, an intense electromagnetic wave with circular polarization is generated by using the magnetic field shown in Figure 1.

In the second stage, the output of the wiggler-free FEL is used for accelerating electrons, known as the gyro-resonance accelerator. This nomenclature derives from the fact that a transverse electromagnetic wave, which can accelerate charged particles moving in resonance with the wave, is autoresonant.

Attachment VI

Although it may be difficult to scale this idea, and this is still a matter of controversy, there is no question that the compact nature of the second stage acceleration is attractive. These individuals should do experiments which will give them a clear knowledge of how scaleable their system is, and how compact the first stage can be made.

Attachment VII

Category I Item: EXCIMER KINETICS -- HEBREW UNIVERSITY, RACAH INSTITUTE

These investigators propose to study the secondary electron kinetics of E-beam pumped excimer laser gas mixtures. These are the typical rare gas halide (so-called exciplex systems), excited complexes of krypton fluoride and xenon fluoride. To date, these data have always been inferred. However, these investigators proposed to obtain direct information on the secondary electrons by measurement of electron density using time resolved interferometry, measurement of the average collision frequency of the secondary electrons by infrared absorption, and measurement of current when an external electrical field is applied. As the investigators point out, drift velocity can be derived from the third measurement, and thus from the second measurement the average electron energy can be evaluated. The laboratory has made a number of advances in this area. They have also pointed out that the computer codes used to obtain electron energy distribution cannot be correct in the case of xenon chloride. As a result, they have also requested funding directly to measure energy distribution by Thompson scattering. As they point out, this is a critical measurement; the Office of Naval Research is currently funding these projects and considers them significant. For example, information obtained by these measurements may enable us to obtain laser action on some of the lines in xenon fluoride which are in the visible; specifically, lines in the 420-500 nm range (C - A transition). It was never clear that obtaining lasing action with major amounts of energy in these lines was practical, but the proposed measurements should provide information on that problem. Of course, intense laser sources in the visible are extremely valuable for a number of applications. In particular it would be useful to obtain wide band tunable lasing action in the visible, which would eliminate the problem of the lead Raman cell for submarine laser communications. The

Attachment VII

**current concepts use a xenon chloride laser operating at 308 nm, with a lead
vapor Raman cell for shifting to 459 nm, compatible with the cesium vapor
filter receiver.**

Racab Institute's proposal is attached.

Attachment VII

KINETIC STUDIES IN EXCIMER LASER MEDIA

Proposal of Hebrew University -- Racah Institute

The following represents an outline of research, directly relevant to SDI objectives, that can be conducted cost effectively at Hebrew University. This research will support ongoing SDI research in the areas of excimer lasers and atmospheric propagation. The first two tasks are focused on developing a more comprehensive model for the kinetic processes in rare gas halide lasers and could lead to invention of new efficient laser systems involving electron beam pumped rare gas systems. These laser systems can not only be scale to the ultra-high power required for negation of ICBMs but can also, in lower power versions find broad applications to interactive discrimination, laser target designation and in development of precise tracking and pointing systems.

The third area of research is centered on providing a more comprehensive understanding of those nonlinear Raman processes in the atmosphere which may play an important role in determining the peak laser power levels which can be transmitted through the atmosphere efficiently. The proposed research would be in three areas: These are:

- o Investigation of the secondary electron kinetics of E-beam pumped as well as E-beam and discharge pumped laser gas mixtures. These include the rare gas halide exciplex systems and other new rare gas laser systems.

In general, the information on the role of secondary electrons in laser performance is derived from elaborate codes which are not altogether accurate or, at the least, have not been verified over a wide range of parameters.

The idea is to collect direct experimental information on the secondary electrons.

The diagnostics are: 1) Measurement of electron density as a function of time by time resolved interferometry. 2) Measurement of the average

collision frequency of the secondary electrons by far infrared absorption. 3).

Current measurement when external field is applied. All measurements will be done as a function of parameters such as gas pressure and composition, E-beam current, E-field strength, etc. From the third measurement, the drift velocity can be derived and from the second and third measurements end average electron energy can be evaluated.

At Hebrew University, lab experiments already are running along these lines with a very modest budget, with interesting results. For example, in measuring for the first time the attachment rate to F_2 in E-beam pumped Ar/ F_2 mixtures, without an external field. Moreover, the results show clearly a considerable dependence of the attachment rate on fluorine density indicating an increase in electron energy with increasing F_2 concentration, which is quite a surprising result but is believed to be understood.

It is anticipated that an investigation would take approximately three years at a budget level of \$60K per year.

o Investigation of the secondary electron energy distribution in E-beam pumped as well as E-beam and discharge pumped laser gas mixtures by Thompson scattering.

Boltzman codes are being used to derive the electron energy distribution. These codes have not been verified experimentally. At least in one case (that of XeCl) the codes cannot be true. The electron energy distribution can be studied experimentally by Thompson scattering. It is a very difficult experiment, but it is doable. We have quite thoroughly analyzed the problem and have designed the experiment including signal to noise evaluation. These measurements can be done on the same systems as in case A and as function of the different parameters.

This project will take 3 - 4 years at a budget level of \$60K a year, i.e.,

Attachment VII

\$180 - 240K total.

o Hebrew University also proposes experimental work in understanding Raman processes which dominate atmospheric transmission and in particular to study the physical aspects of the relationship among gain, frequency spread, dispersion and phase front control.

The existing major equipment in the lab includes:

- E-beam (cable gun, 300 nsec, 150KeV, 15A/cm²).
- Biomatin digitizer with 2Sec/div resolution, hooked to Apple computer, for time resolved recording and analysis.
- Spectrometers (variety) + OMA hooked to Apple computer for spectrum recording and analysis.
- Appollo CO2 laser + F.I.R. laser for I.R. interferometry and far infrared absorption.
- Ruby laser -- for Thompson scattering.
- Power supplies (variety):
- Vacuum system and pumps (variety).
- Detectors and photodiodes (variety).

There also is a Lambda Physik short pulse excimer laser + dye laser and a CW Nd Yag laser. For major numerical analysis the University has a Cyber computer 180 - 855 C.D.C.

CATEGORY I ITEM: PLASMA DETECTORS - RAFAEL

Scientists at Rafael have come up with an ingenious way of using the properties of a glow discharge plasma to detect microwave and millimeter waves. The attractiveness of the project lies in the ability of the discharge to withstand nuclear weapons effects. A glow discharge plasma operates at a few hundred volts of applied voltage with current densities varying between 10^{-5} and 10^{-1} amperes per square centimeter. The Rafael investigators indicate that a focal plane array can be constructed of glow discharge elements to image microwave and millimeter wave radiation. These tubes work on the principle that when an electromagnetic wave illuminates the glow discharge tube, the voltage current characteristic of the tube changes. Changes in the tube characteristics are reflected as a voltage change across a load resistor. In this manner the glow plasma functions as a video detector. Work on these types of devices was initiated around 1965. In the early 1980's, Rafael carried out research on the interaction between electromagnetic waves and the glow discharge plasma and, according to the investigators, this information is sufficient to design tubes.

A major question with these types of detectors is sensitivity. A program should be carried out to determine whether their sensitivity can be high enough to compete with solid state detectors.

The investigators list a number of the advantages of this type of device. They point out the tube is self contained and does not have to

be fixed in a wave guide as does a solid state detector and the detection is a "volume" effect; the wave is absorbed throughout the plasma. Since an absorption can take place throughout the volume of the tube the radiation needs not be focused or concentrated in a small area such as would be required of a solid state device. This capability may also indicate a decreased sensitivity. Another advantage is the fact that these arrays can remain quite small and that larger arrays are currently being fabricated as panel displays or plasma displays, a reflection of the fact that it is possible to fabricate and assemble these devices in large numbers. The principal advantage, however, is the resistance of these devices to a nuclear environment. They have resistance to high power microwave radiation, high power lasers, EMP, and blast, heat and radiation from nuclear explosions. The devices have a fast response time and are inexpensive. However, the principal issue is sensitivity. The investigators should determine the sensitivity which one could expect by optimizing the detectors. Furthermore, there should be a system study done to see whether the sensitivity hypothesized is sufficient for detection requirements for tactical or strategic applications.

CATEGORY 1 ITEM: SOFTWARE LOGIC - RAFAEL (& OTHERS)

It is well known that real time software cannot be thoroughly tested and that 100% assurance of reliability and correctness cannot be provided purely using this approach. Recently, this has been publicised by D.L. Parnas as a particularly serious issue for SDI. An alternative approach using formal methods based on mathematical logic can be used for the specification of requirements followed by the demonstration of correctness of the resultant software relative to the formal specification. The SIFT project done by SRI for NASA in 1977 points to the feasibility of this approach, although there was no sequel. Some experts do not believe that this approach can be scaled up to large software systems.

However, recent technological advances and continuing work being done by the Israeli's in this area offers hope of significant improvement in software reliability. These advances include temporal logics for specifying and verifying concurrent programs, advanced workstations for software specification and verification, and AI software for theorem proving. The researchers at Rafael have applied SRI's Interval Temporal Logic to an actual software system.

It is recommended that SDIO consider funding some work of this nature in Israel. The focus for this work could be Dr. Mordechai Ben-Ari of Rafael and Technion. Others doing relevant work are Profs. Amir Pnueli, Zohar Manna and David Harel of the Weizmann Institute of Science as well as a group at Israeli Aircraft Industries.

CATEGORY I ITEM: COMPUTER VISION - ELBIT

Research on computer vision has been carried out by Mr. Ilan Tanches of Elbit for the past five or six years. The objective of this research has been severalfold. The first is to provide a digital representation of an image an efficient manner, thus providing data compression. The second is to provide pattern recognition in an adaptive manner for target recognition and discrimination applications. The third is that the algorithms should be computationally efficient and lend themselves to an efficient computer architecture so that they can be carried out rapidly, and by a physically small, light weight and low power package appropriate to tactical applications and even expendable use.

The algorithm, developed by Mr. Tanches, consists of searching for areas of interest, mapping the field of view into a set of characteristic transform coefficients, and then pattern recognizing by means of discriminant functions applied to these coefficients. This is boiled down to a discriminant operator (by a learning process) which produces a single number, which if positive implies a target or if negative implies background. The coefficients are derived by transforms (masks of the image in ways related to how the eye and the brain process imagery and how a person searches for patterns. Some initial theoretical work was done along this line at MIT by Yubet and Weizel in 1981. The algorithm takes into account the dimensions of color, motion, and stereo. The algorithm does not distort the image and is invariant to rotation, position and size. Elbit has achieved 98.5% classification success for the algorithm on tactical type targets.

Attachment X

The computing power required by the algorithm is 0.5 Giga-instructions per second, which provides search and detection rates of 7 (512 x 512) frames per second. A special purpose processor for implementing the algorithm has been built using a parallel architecture. It weighs 33 lbs., has dimensions of 8"x8"x12", consumes 200 watts, and costs under \$100K.

This approach holds promise for being a significant advance in the area of real time target identification and location as well as data compression for conventional and strategic applications.

Electronic Warfare

The Israel Forces utilize Electronic Warfare as a segment of their integrated defense forces. This aspect of electronics is combined with electronic intelligence, communications, reconnaissance and weapons within the C3I network. Results indicate a very effective use of EW to protect critical elements of equipment and personnel and provide a very effective "soft kill" capability to supplement weapon systems.

Israeli aircraft utilize equipment and DoD systems built to U.S. standards, compatible Radar Warning Receivers (RWR), decoys, ECCM devices and procedures, as well as dedicated electronic combat aircraft for effectiveness within the close confines of range, reaction time and threats.

The aircraft systems are supplemented by drones that provide real-time target data directly to the cockpit of tactical aircraft. Israel has command type aircraft (Boeing 707, etc.) that provide C3I for air operations.

Ground systems include several configurations of vehicle and fixed base systems capable of complete tactical C3I, and include HF/DF and full SIGINT capabilities. The naval command also has an integrated C3I system with fully operational fixed site and shipboard systems.

All facilities are integrated into a secure intelligence/command/communications system that controls all military operations.

Key factors in technology associated with the electronic combat systems include:

- o VLSI Circuits
- o Real-Time Processing
- o II Processing Capability
- o Extensive Microelectronics at all levels
- o Application of known technology at all levels.

An example of utilization of technology includes airborne equipment with a VLSI circuit (2 micron size, 12K gates) integrated into a miniature device with a SAW (Surface Acoustic Wave) element that is totally reprogrammable and capable of providing single pulse processing to the antennae of an airborne radar.

This example of processing precise and critical points of information is a strength that is implemented in Israeli electronic systems.

The electronic combat systems are designed and fully functional for Israel and the 50 mile wide geographic constraints of the country. The need for fully operational indications and warning, threat assessment and 24 hour reliability of EW equipment to effectively counter an attack is reflected in the Israeli systems.

The designs are basic and employ existing technology in fielded devices. The integration of various devices into field systems is very apparent and functions as an integrated C3I system for all ground, air and naval operations.

The maximum available substrate width (about 2") and the requirement that the transducer be several tens of wavelengths wide for efficient operation limit the lower frequency to about 10 MHz. The upper limit of 1 GHz is due to mask fabrication and photolithographic constraints, as well as to propagation losses.

The maximal relative bandwidth for reasonable insertion loss and second order effects is about 40%, while the minimal bandwidth is of the order of 0.1%.

The maximum available length of substrate (about 6") limits the maximum delay to 50 microseconds, while the minimal delay of several hundred nanoseconds is due to RF isolation difficulties if the two transducers are too close to each other.

SAW devices, being completely passive, feature a high dynamic range relative to noise, despite the relatively high insertion loss. They also feature high bandwidth and center frequencies as compared to digital, CCD or crystal devices. Compared to lumped element components, they exhibit the well-known microelectronic advantages of small size, high reproducibility, ruggedness and freedom from tuning. Their performance, particularly of matched filters and pulse compressors, is unique.

Typical Applications of SAW CHIRP Filters:

- o Radar Pulse Compression: Improves resolution for a given range or for jamming immunity.
- o Fast Frequency Synthesis: Mixes the output of two CHIRP expanders impulsed with a variable delay.
- o ESM Compressive (Microscan) Receivers: Based on two CHIRP filters, provide a fast real-time analysis of a wide frequency bank with good resolution.
- o Fourier Transform Processors: Provide real-time analysis of both amplitude and phase.
- o Variable (Voltage-controlled) Delay Lines
- o Time Compression/Expansion or Reversal Systems

Attachment XI

SAW Phase Coded Matched Filters - Performance Range

Parameter	Symbol	Existing Designs	Design Capability
Center Frequency	f_0	60 - 70 MHz	up to 400 MHz
Bit Rate (Bandwidth)	B	5 - 12 Mbs	up to 100 Mbs
Code Duration	T	6 - 25 μ s	up to 30 μ s
Code Length	$N = BT$	32 - 300 bits	up to 1000 bits
Modulation		PSK, MSK Fixed Code or Programmable	

SAW Chirp Compressors/Expanders

Model Parameter	ST 4007	ST 4101	ST 4102	ST 4103	ST 4201	ST 4202	Design Capability
Center Frequency (MHz)	60	180	60	60	60	550	700
Bandwidth - B [Expander] (MHz)	20	50	6.3	6.1	17	190	200
Dispersive Delay - T [Expander] (μ s)	25	18	3.4	4.8	17.5	0.4	25
T x B Product	500	900	21	29	300	76	1000
Compressed Pulse Width at -4dB (ns max)	55	25	290	290	83	6	--
Sidelobe Level (dB)	-13	-13	-24	-24	-35	-13	13-35
Insertion Loss (dB)	53	45	26	26	42	31	--

**Attachment XI
SAW Filters and Delay Lines Performance Range**

Parameter	Symbol	Design Capability
Center Frequency	f_0	10 - 700 MHz
Fractional Bandwidth @ -3 dB	$\Delta f/f_0$	0.1% - 40%
Group Delay	-	0.5 - 50 μ s
Shape Factor	S.F.	down to 1:10:1
Sidelobe Rejection	R	up to 60 dB
Amplitude Ripple	A_r	down to ± 0.3 dB
Phase Deviation from Linearity ptp	ϕ_r	down to 1°
Group Delay Variation ptp	GD_r	down to 50 ns
Insertion Loss	I.L.	3 - 30 dB

SAW Bandpass Filter Types

Type	Center Frequency MHz	3dB Bandwidth MHz	Rejection Bandwidth at 40 dB MHz	Stopband Rejection dB	Insertion Loss dB
ST1911	35.25	0.3	0.6	40	11
ST1910	35.25	0.8	3.2	40	15
ST1308	35.25	1.1	3.9	40	30
ST1201*	43.5	5.0	5.75	40	24
ST1309	60.0	0.4	2.0	55	15
ST1922	60.0	0.5	1.4	50	11
ST1921	60.0	0.9	2.1	50	10
ST1314**	60.0	1.9	6.9	25	5
ST1923	70.0	1.6	4.8	50	12
ST1320	100.0	0.4	1.8	60	15
ST1925***	110, 120, ...200	0.8	2.3	50	18

* Vestigial sideband filter - NTSC standard ** Low loss *** Filter bank

SAW Delay Line Types

Model	Center Frequency MHz	3 dB Bandwidth MHz	Delay μ s	Insertion Loss dB
ST1310	10.0	0.5	0.82	23
ST1912	60.0	2.1	13.31	18
ST1202	550.0	200.0	3.3	30

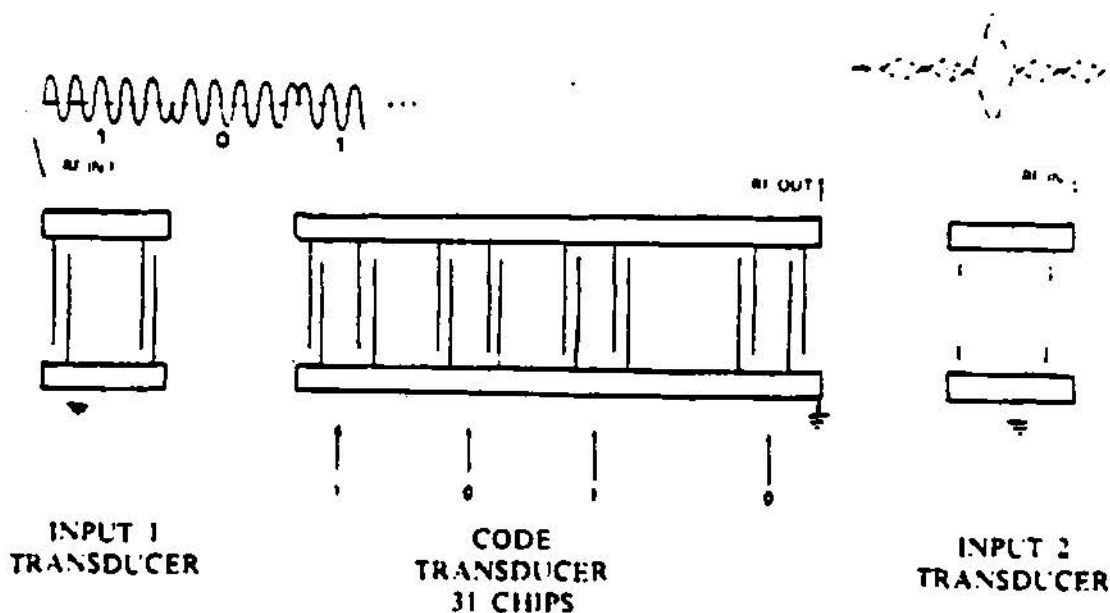

SAW Convolver

CHARACTERISTIC	TYPE ST2206S	TYPE ST2206L	DESIGN CAPABILITY
Input 3 dB Bandwidth	16 MHz	16 MHz	to 120 MHz
Integration Time	11 μ s	17 μ s	to 30 μ s
Input Center Frequency	60 MHz	60 MHz	to 400 MHz
Bilinearity Factor *	-79 dBm	-79 dBm	to -70 dBm
Dynamic Range **	up to 60dB	up to 60dB	-
Maximum Input Power	25 dBm	25 dBm	25 dBm

Notes:

- * The bilinearity factor or convolver efficiency is defined as $10 \log[P_{out}/(P_{in1} P_{in2})]$ where powers are in mW.
- ** The dynamic range is the power range of the input signal, when the reference signal is fixed at +25 dBm. It is a function of the signal time duration and character.
- *** A bandpass filter is required at the convolver output, in order to reject signals at the input frequency.

SIGINT

Signals Intelligence Systems provide accurate geographic location of specific electronic signals from hostile C3I and weapon systems.

The Israelis have developed high speed programmable signal processing devices for both sonar and radar systems, as well as electronic warfare and electronic intelligence systems.

The basic features that have been successfully exploited are:

- o Programmable signal processing.
- o Parallel processing.
- o Stand-alone and system integration design.
- o Accurate range and location algorithms.
- o Specific emitter identification.

The basis of ELTA's software is a ring bus architecture called the Octopus, which allows multi-sensor fusion of data with individual signal processing nodes. These nodes interface into a master communications system and retain their stand-alone capability for independent use or degeneration of the system.

The parallel processing capability comes from the "Butterfly" concept under license to IAI from BBN.

Other capabilities include:

- o Encryption/Decryption of voice and data.
- o Real-time signal analysis.
- o Multi-sensor correlation.

The Israeli's system approach to SIGINT processing has taken advantage of existing high technology and has integrated components into field hardware.

The following data illustrates the Octopus architecture and its processing times:

PE Calculation Speed

Execution Time/Speed

Addition	90 ns
Multiplication	180 ns
Reciprocal	360 ns
Division	540 ns
Square Root	360 ns
Sin/Cos	540 ns
FFT Butterfly	540 ns

Impact of VHSIC on Airborne Signal Processor

	<u>Today*</u>	<u>With VHSIC Technology</u>
Throughput (MCOPS)**	7.1	50
Power Dissipated (kW)	1.3	0.1
Volume (FT)	1.0	0.1
Number of ICs	3000	35

***F-15 & F-18 Hughes Programmable Signal Processor (PSP)**

**** MCOPS - Million complex radix two butterflies per second. The butterfly is a subalgorithm of the Fast Fourier Transform (FFT) algorithm. It consists of four real multipliers and six read adds.**

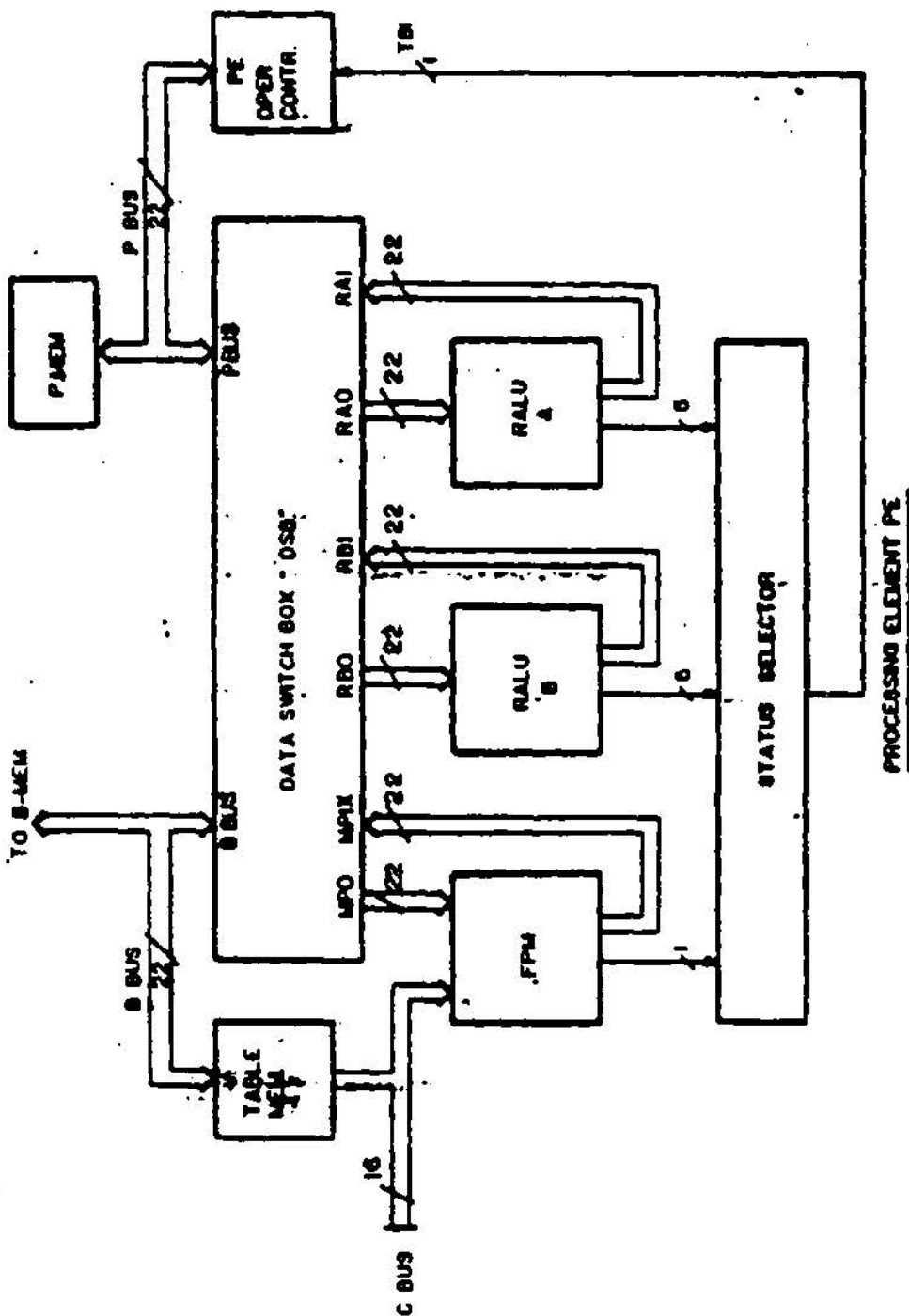

XII-3

OCTOPUS - BLOCK DIAGRAM

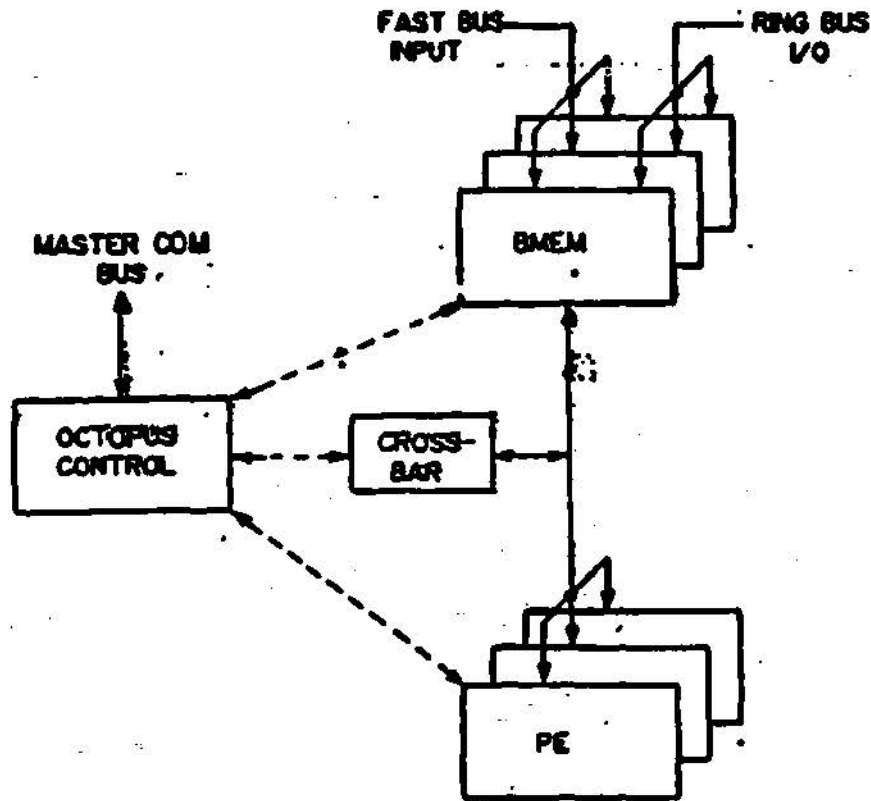

PSP CHARACTERISTICS

CHARACTERISTIC	NUMBER OF OCTOPUS		
	1	2	3
COMPUTATION RATE (MOPS)	260	520	780
NUMBER OF MODULES	9	19	28

(FOR 1A PE/OCTOPUS)

Attachment XIII

TADIRAN

Major Efforts:

- o **Complete Airborne Systems for:**
 - **EW**
 - **Electronic Intelligence**
 - **Communications**
 - **Command Security**
 - **Reconnaissance**
- o **Complete facilities to develop and integrate systems using a high electronic content. These equipments utilize state-of-the-art components in configurations that include preset development and unique composite technologies that match specialized tactical situations.**

They are providing a drone system for the U.S. Navy that will include:

- o **3 Groundstations**
- o **20 Drones**
- o **9 hour air endurance**
- o **1 kW Power onboard**
- o **Resolution of .1 sq m radar cross section**
- o **12,000 ft operational altitude**

Aircraft systems include:

- o **ELINT**
- o **SIGINT**
- o **RADINT**
- o **COMINT**

Full 707 configuration through F-16 fighter utilization.

19% of shares owned by GTE. U.S. subsidiary is NUMAX.

R & D share of gross revenue is 11.4% of sales (\$65M).

Sales \$570M (1985).

12,000 personnel.

EW/DF & Emitter Location

TDF-205

Automatic mobile, shipboard or stationary direction finding system. Operates in 20 to 500 MHz band using interferometry. Detects voice and data radio transmissions and determines their direction of arrival (DOA). Accuracy 1.5° rms.

TDF-500

Automatic airborne direction finding system operates in 20 to 500 MHz band using interferometry. Calculates DOA of detected signals quickly and accurately. Can be installed in a variety of aircraft and helicopters and multi-tasked by up to 10 operators. Incorporated in Aircrew Rescue System. Accuracy 1.5° rms.

TDF-300

Automatic heliborne DF System for aircrew rescue systems. Operates together with PRC-434 transponder.

TDF-230

Ruggedized HF DF system (1.5 to 30 MHz) for installation in APCs, mobile shelters or aboard ship. Automatic Adcock-type, single channel system.

TELEGOLAN SR-3

Compact, lightweight DF covering 20 to 200 MHz band, easily installed on small vehicles. Using the Adcock technique, automatically measures direction of arrival and continuously displays results. Will screen according to the azimuth sectors entered by operators.

FIX-500

Emitter location finding system for VHF and UHF communication band (20 to 500 MHz).

FIX-3000

Emitter location finding system for HF communication band (1.5 to 30 MHz.). Accuracy 1.0° rms.

Command, Control, Communication & Intelligence (C3I)

C3I Centers

Provide real-time pictures of deployment and progress of both friendly and enemy forces on land, at sea and in the air. Systems incorporate computers, line, radio and radio-telephone equipment, teleprinters, tactical digital terminals, tactical graphic displays and secure communication devices. Transmission and switching, data processing and analysis are performed at these centers.

DACCS (Divisional Artillery Command & Control System)

Provides commander with automatic real-time acquisition, processing and dissemination of data for control of artillery. Maximizes number of targets that can be engaged by weapon array and increases the effectiveness of immediate counter-battery fire. Comprises system data base, target acquisition, data entry and retrieval, decision support and communications.

TACDIS Divisional C3I System

Divisional level command and staff system for message exchange, intelligence information and friendly forces data management, situation analysis, mission planning and monitoring services. Maintains accurate actual situation picture and permits access, presentation and analysis of elements of that situation picture.

NAVALIS (Naval Intelligence System)

Naval command and staff system with functions similar to TACDIS.

CV-1005

Mobile C3I center with HF, VHF-FM, VHF/UHF-AM radio sets, TACTER-10 digital graphic terminal and encryption facilities.

CV-2005

Mobile multifunction communications center providing radio-telephone, microwave and fiber optic links for voice and data.

MIDAS (Message Integration, Distribution and Switching System)

Automatically distributes and routes preformatted and free-text messages to a network of display terminals and printers. For all types of strategic and tactical systems.

Attachment XIII-B

COMTAC C3I Console

Receives and presents graphically strategic and tactical information including electronic maps with tactical overlays for comprehensive overview of the battle situation. Remote video display from mini-RPV systems, automatic communication control and extensive data processing capabilities are incorporated.

EW COMINT, COMJAM & ELINT

COMINT-Series 6000

Microprocessor-controlled real-time system operating in VHF/UHF band (20 to 500 MHz) automatically scans and detects communication signals. Has means for display, monitoring and DF. Stores and transmits digital messages.

COMINT-Series 9000

Completely automatic system for scanning, detection and recognition of voice and data HF signals (5 KHz to 30 MHz) with a variety of modulation modes. Includes display unit and has message handling capability.

COMJAM-Series 7000

Mobile systems, operating over rough terrain in hostile environments, search, identify, monitor and disrupt enemy communications without interfering with friendly communications. Cover the freq range 1.5 to 500 MHz according to need, with high power transmission from 100W to 10 kW. Operation modes include spectrum scanning, "hunting" and operator-oriented hands-off method.

RAS-1B

Airborne radar analysis system for detection, identification and location of hostile radar emitters. Covers 0.7 to 18 GHz band. Fast acquisition, accurate location, precise measurement and fast processing of all existing signals. Generates an Enemy Order of Battle (EOB) map showing radar and weapon systems in area. Direct on-line airborne operations against active weapon systems, devises and programs countermeasure and avoidance operations.

RASAD

Radar signals analyzer/deinterleaver measures complex, mixed and intelligence radar signals, deinterleaves, computes parameter and displays results. Can be integrated into conventional ELINT systems.

TACDES

Airborne SIGINT system performs real-time acquisition, identification, location, processing and reporting of communications and radar systems in the 20 MHz to 18 GHz band. Incorporates RAS-1B, ACS-500C COMINT, MUDF-500C DF and computerized C3 systems. Fully integrative system with enhanced command and control capability and real-time secure voice and data communications.

Attachment XIV

ELTA - "LAVI" AVIONICS

ELTA Electronics Industries, Ltd., a subsidiary of Israel Aircraft Industries Ltds., has been elected as prime contractor for the design and supply of three major segments of the "LAVI" Avionics:

THE AIRBORNE RADAR

This is a modern multi-mode radar adaptable to a wide range of combat and surveillance missions. As a sensor of the Weapon System, the radar determines both airborne and ground target data such as position, velocity and acceleration. Its coherent transmitter and stable multichannel receiver assure reliable look-down performance over a broad band of frequencies as well as accurate resolution for mapping. A modern programmable signal processing unit, backed up by the distributed computer network, permits an optimal allocation of computing power for the radar's many modes. This system also has a great deal of flexibility so that new and updated processing algorithms are easily implemented.

THE EW SYSTEM

This advanced self-protection EW System is fully automatic and power managed. Based on modern architecture backed up by a distributed computer network, it permits flexible and optimal allocation of a wide range of resources. The integrated ESM/ECM computer control system enables identification of threat emitters and automatic response using jamming and deception techniques. The optimal architecture and powerful computing subsystem allow both identification and response in tomorrow's dense multi-threat environment.

The system is designed to enable the "Lavi" fighter to complete its mission by providing protection and substantially enhancing its survivability and unassailability.

THE COMMUNICATION SYSTEM

Specially designed to withstand severe types of disturbances, the unit is fully computerized and enables operation from various control protocols including MIL-STD-1553B Mux-Bus interface.

The overall ELTA role for avionics for the LAVI is more than 60% of the total equipment.

AIRBORNE SIGINT

The primary facility for Airborne Sigint is the ASHDOO based operations that integrates total systems for Israeli tactical and strategic operations. The basic hardware includes:

- o COMINT, ELINT, and Command Analysis
- o Enemy Deployment Data
- o Detailed Electronic Signature Data Bases

The ELINT system locates and identifies radar emissions. The COMINT system intercepts pertinent radio transmissions and is capable of recording or real time display.

System operation is from an airborne multi-engine platform with operational altitudes of 36,000 feet and 1^o accuracies out to 400 km.

Ground systems supplement the processing for additional detailed analysis and command and control functions.

Frequency coverage includes:

- o ELINT .5 MHz - 18 GHz, 70 MHz - 40 GHz
- o COMINT 20 MHz - 500 MHz, 2 MHz - 1000 MHz

The equipment is housed in a Boeing 707 type aircraft.